

e-chains® | Series E6.52 crossbars every 2nd link (crossbars removable along both radii)
e-tubes | Series R6.52 fully enclosed (lids can be removed along inner and outer radius)

Part No. e-chains® / e-tubes	<i>Bi</i> [mm]	<i>Ba</i> [mm]	E6.52 [kg/m]	R6.52 [kg/m]
E6.52. R6.52.* 040. R.0	40	64	≈ 1,76	≈ 1,78
E6.52. R6.52. 050. R.0	50	74	≈ 1,80	≈ 1,89
E6.52. R6.52.* 052. R.0	52	66	≈ 1,81	≈ 1,92
E6.52. R6.52.* 062. R.0	62	86	≈ 1,84	≈ 1,97
E6.52. R6.52.* 070. R.0	70	94	≈ 1,87	≈ 2,07
E6.52. R6.52. 075. R.0	75	99	≈ 1,89	≈ 2,12
E6.52. R6.52.* 087. R.0	87	111	≈ 1,94	≈ 2,21
E6.52. R6.52. 100. R.0	100	124	≈ 1,98	≈ 2,35

Part No. e-chains® / e-tubes	<i>Bi</i> [mm]	<i>Ba</i> [mm]	E6.52 [kg/m]	R6.52 [kg/m]
E6.52. R6.52. 125. R.0	125	149	≈ 2,07	≈ 2,57
E6.52. R6.52. 150. R.0	150	174	≈ 2,17	≈ 2,80
E6.52. R6.52. 175. R.0	175	199	≈ 2,26	≈ 3,03
E6.52. R6.52.* 200. R.0	200	224	≈ 2,36	≈ 3,25
E6.52. R6.52.* 225. R.0	225	249	≈ 2,45	≈ 3,46
E6.52. R6.52.* 250. R.0	250	274	≈ 2,54	≈ 3,68
E6.52. R6.52.* 275. R.0	275	299	≈ 2,64	≈ 3,92
E6.52. R6.52.* 300. R.0	300	324	≈ 2,73	≈ 4,15

*Width available upon request, please consult igus® for delivery time!

Available bending radii *R* [mm] 075 | 100 | 150 | 200 | 250 |

Supplement Part No. with required radius (*R*). Examples:

E6.52.100.100.0 = e-chain® with crossbars every 2nd link, inner width *Bi* 100 mm, radius *R* 100 mm, color black

R6.52.100.100.0 = e-tube fully enclosed, inner width *Bi* 100 mm, radius *R* 100 mm, color black



▶ 656



▶ 708

Unsupported applications | Short travels

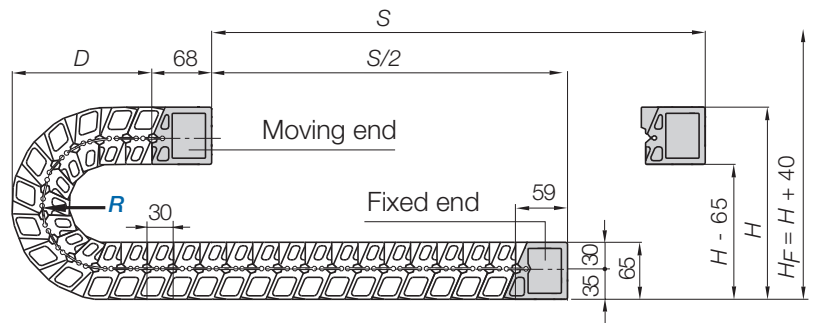
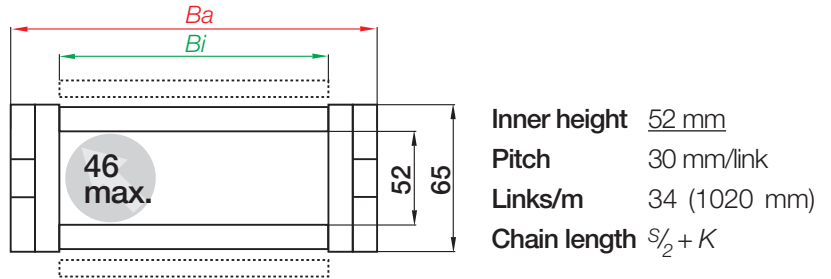
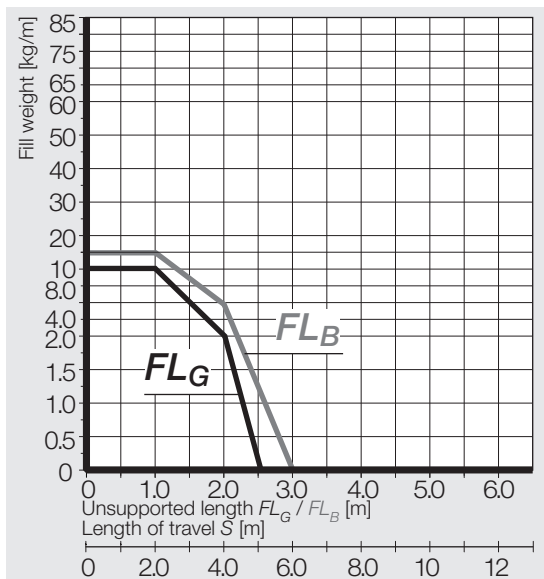

R	075	100	150	200	250
H	270	320	420	520	620
D	155	180	230	280	330
K	300	375	535	690	850

The required clearance height: $H_F = H + 40$ mm (with 2,0 kg/m fill weight)

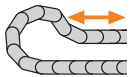

If you need this series for gliding applications, please consult igus®!

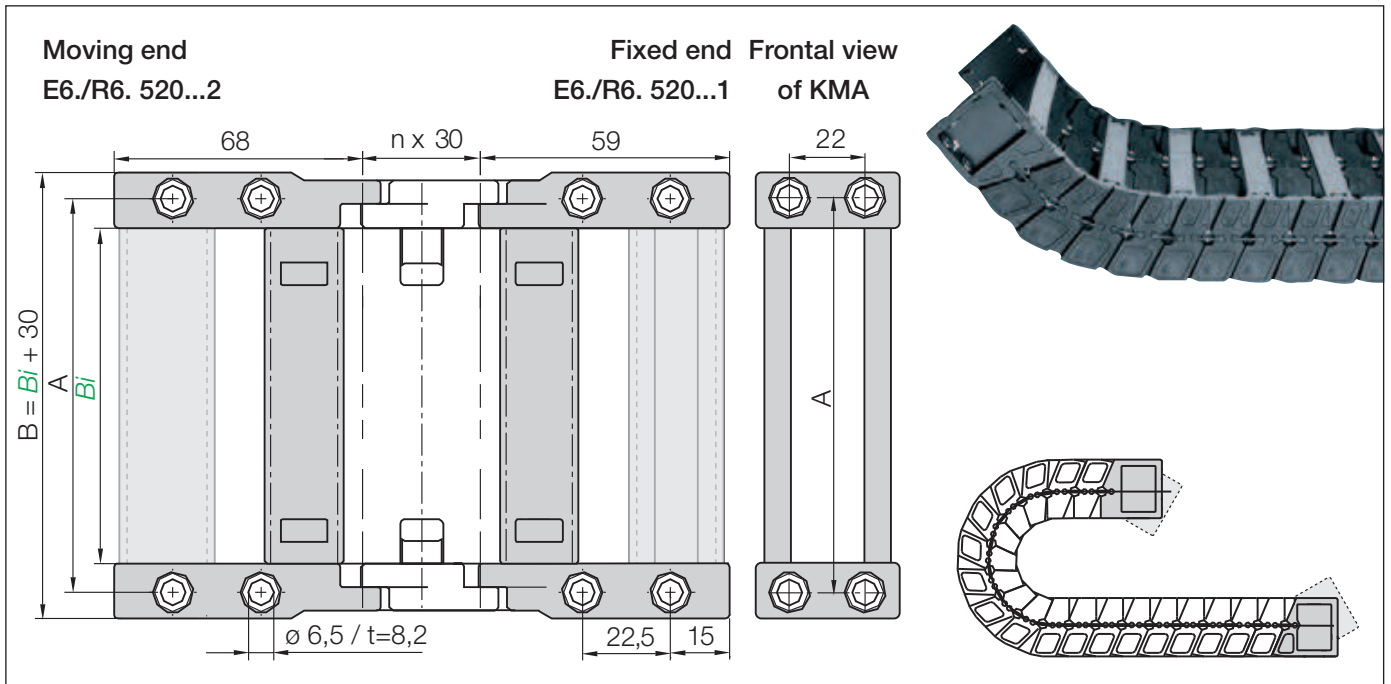

KMA pivoting | Recommended for unsupported applications | Standard

Width Index	Part No. full set KMA pivoting: (optional with C-profile)	Dim. A [mm]	Dim. B [mm]	Bi [mm]	Width Index	Part No. full set KMA pivoting: (optional with C-profile)	Dim. A [mm]	Dim. B [mm]	Bi [mm]
040.	▶ E6.520. R6.520.* 040.12.C	56	70	40	125.	▶ E6.520. R6.520. 125.12.C	141	155	125
050.	▶ E6.520. R6.520. 050.12.C	66	80	50	150.	▶ E6.520. R6.520. 150.12.C	166	180	150
052.	▶ E6.520. R6.520.* 052.12.C	68	82	52	175.	▶ E6.520. R6.520. 175.12.C	191	205	175
062.	▶ E6.520. R6.520.* 062.12.C	78	92	62	200.	▶ E6.520. R6.520.* 200.12.C	216	230	200
070.	▶ E6.520. R6.520.* 070.12.C	86	100	70	225.	▶ E6.520. R6.520.* 225.12.C	241	255	225
075.	▶ E6.520. R6.520. 075.12.C	91	105	75	250.	▶ E6.520. R6.520.* 250.12.C	266	280	250
087.	▶ E6.520. R6.520.* 087.12.C	103	117	87	275.	▶ E6.520. R6.520.* 275.12.C	291	300	275
100.	▶ E6.520. R6.520. 100.12.C	116	130	100	300.	▶ E6.520. R6.520.* 300.12.C	316	330	300

*Width available upon request, please consult igus® for delivery time!

(KMA = Polymer Metal Mounting Bracket)

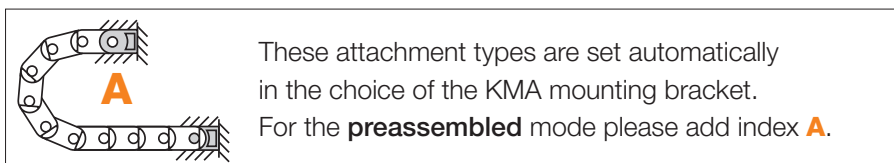

E6.520.100.12.CA Part No. structure

- A... must be indicated on preassembled configurations
- C-profile option
- Full set
- Width index
- Series

 **Strain relief** e.g. clamps, tiewrap plates, nuggets and plug-in clips are available from stock. The complete chainfix range with order options ▶ from page 656

Interior separation | New generation | Only for e-chains® (e-tubes ▶ next page)

Previous interior separation with optional elements ▶ www.igus.eu/E6.40

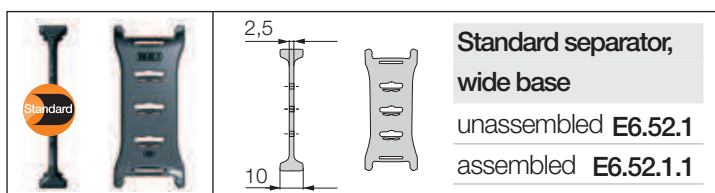
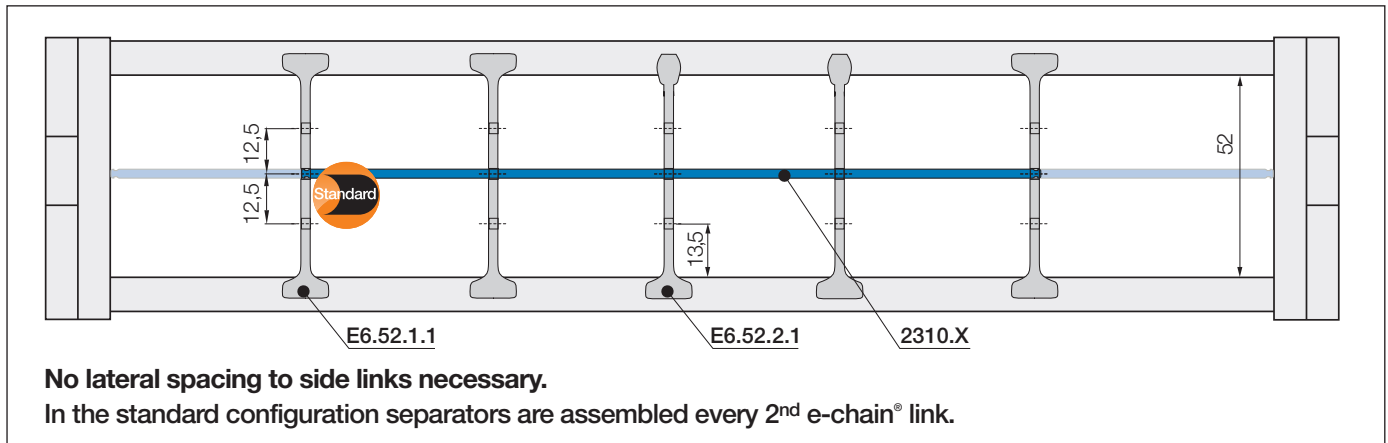

Standard - for all applications

Separator with a wide base for maximum locking strength and safe standing in e-chains®.

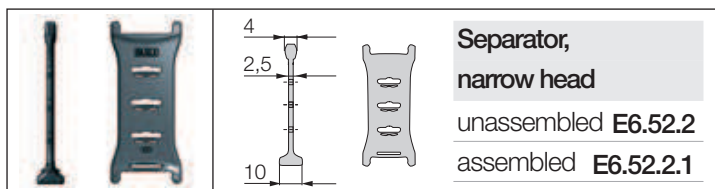

For even faster installation

Firm hold to one side with a wide base, narrow on opposed side for easy cable assembly (slight grip).

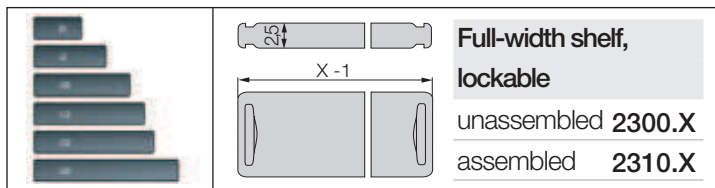

Horizontal separation

Shelf locks safely into separators on both ends, fixed width possible. Separators can be moved freely over the shelf in horizontal direction. Can be arranged at 3 different heights.



Lockable full-width shelves - for the standard interior separation

Width X [mm]	unassembled	assembled	Width X [mm]	unassembled	assembled	Width X [mm]	unassembled	assembled
015	2300.015	2310.015	060	2300.060	2310.060	087	2300.087	2310.087
025	2300.025	2310.025	062	2300.062	2310.062	090	2300.090	2310.090
030	2300.030	2310.030	065	2300.065	2310.065	100	2300.100	2310.100
038	2300.038	2310.038	070	2300.070	2310.070	103	2300.103	2310.103
040	2300.040	2310.040	075	2300.075	2310.075	110	2300.110	2310.110
050	2300.050	2310.050	077	2300.077	2310.077	120	2300.120	2310.120
057	2300.057	2310.057	080	2300.080	2310.080	125	2300.125	2310.125

E6 | Series R6.52 | Accessories

Interior separation | Only for e-tubes (e-chains® ► previous page)

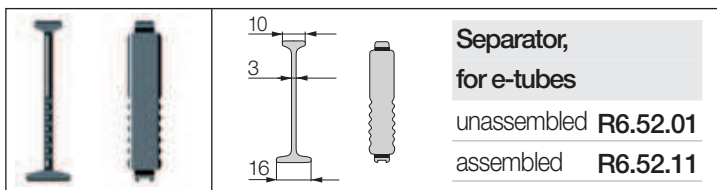
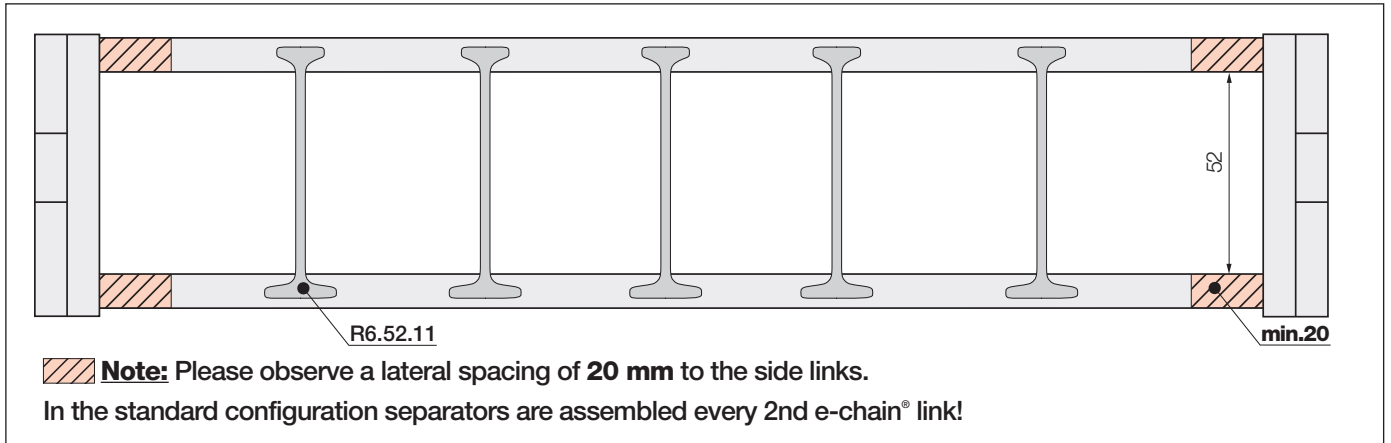

Separator R6.52.01 (e-tubes only)

For e-tubes R6.52. The notches on this separator mark the side that fixes to the lid.

Optional: Support tray tool kit.

For support of the lower run.

Simple one-piece support trays according to your requirements and specification.
The complete range with order options ► from page 740

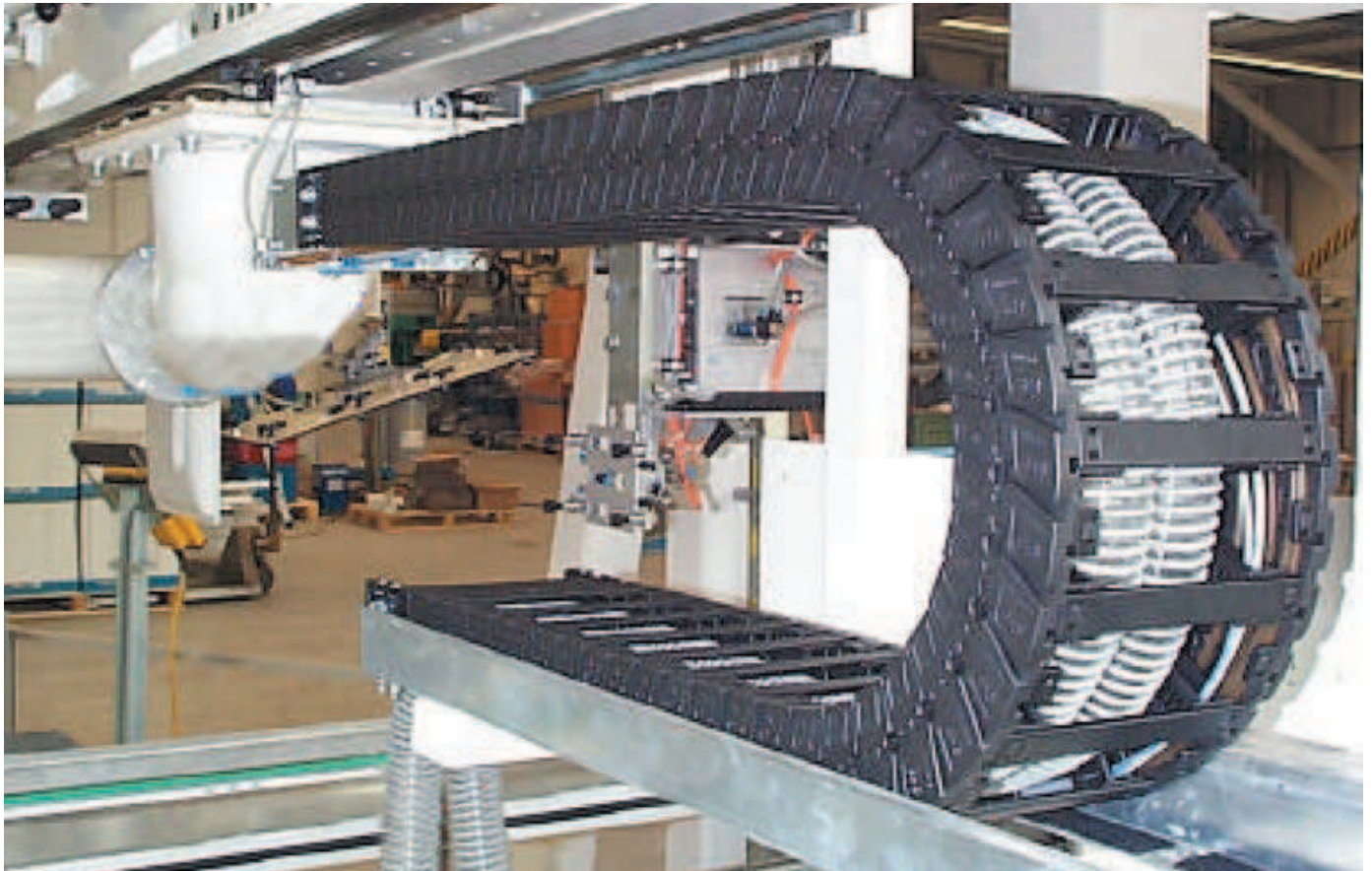
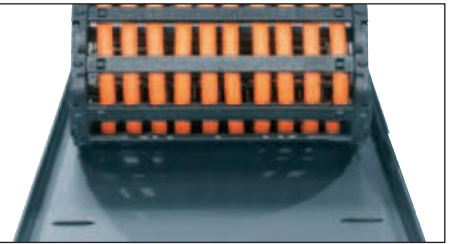

igus® System E6, pick and place robot - speed 8 m/s, acceleration 78,5 m/s²