



**ELECTRIC
ACTUATORS**

NEW

Economy series

ES/EC

Stepper Driver Controller

TSC

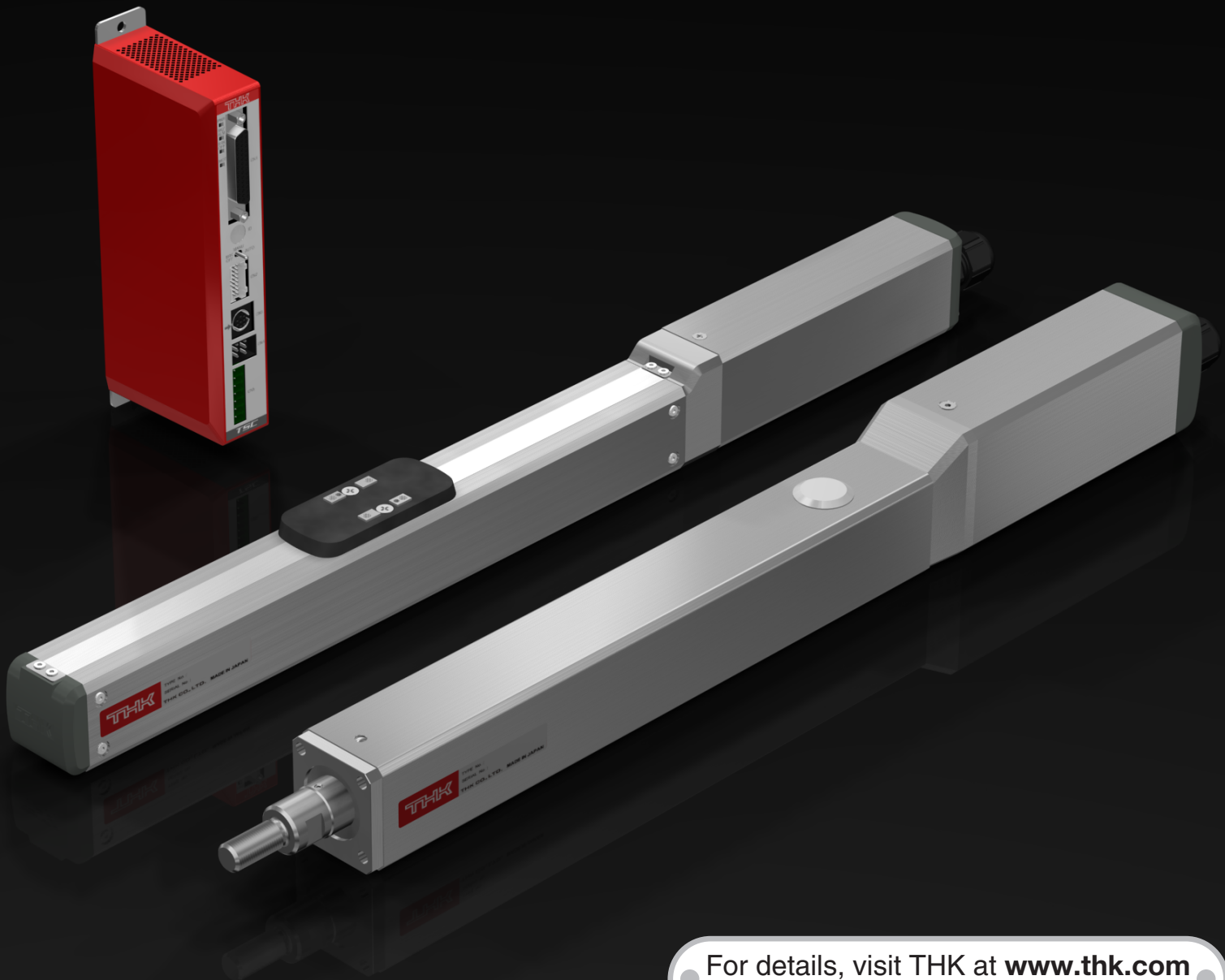

For details, visit THK at www.thk.com

* Product information is updated regularly on the THK website.

THK CO., LTD.
TOKYO, JAPAN

CATALOG No.364-5E

Electrical Actuator Economy series ES/EC

Lightweight, Compact

Slider Type
ES

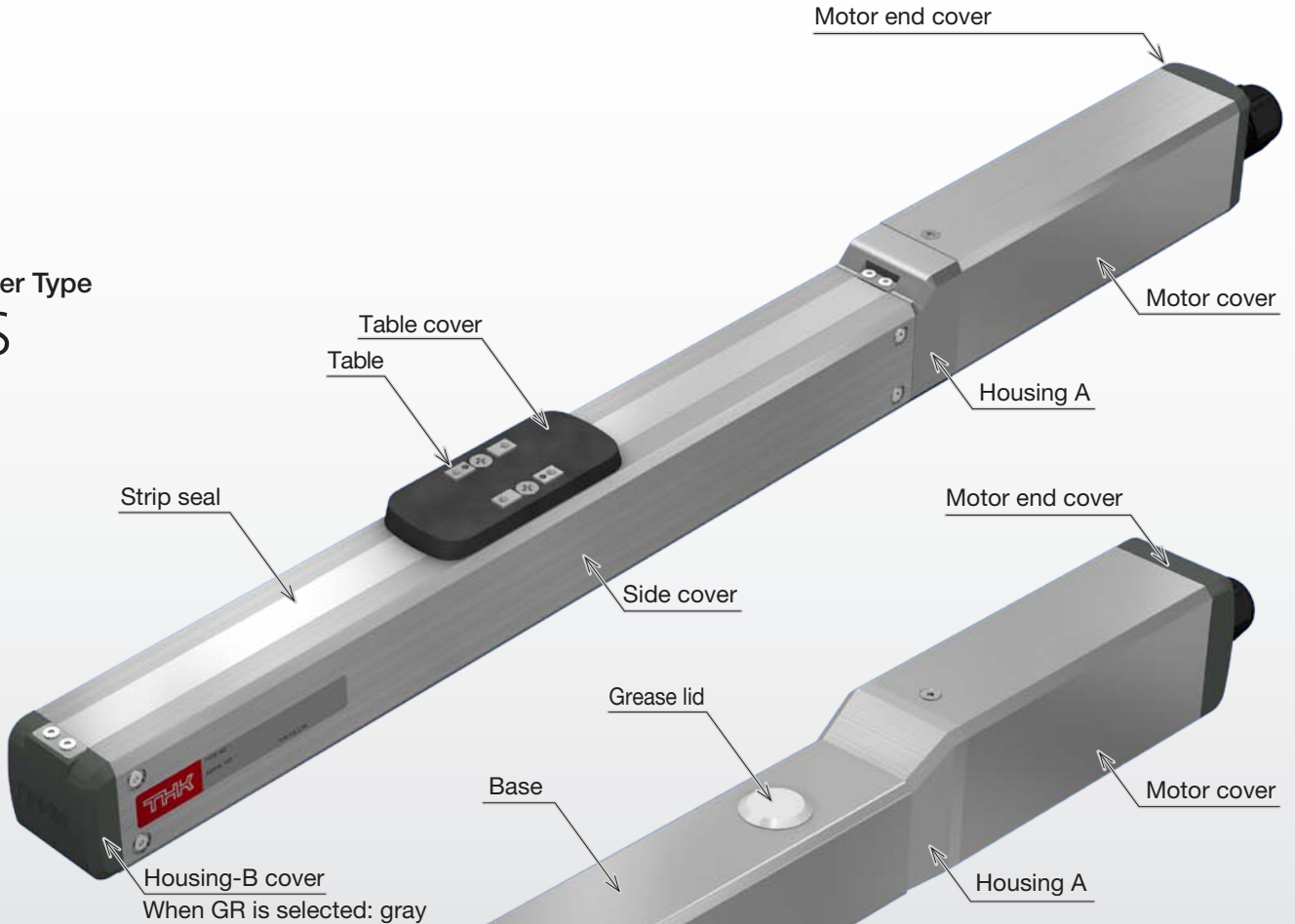

Cylinder Type
EC

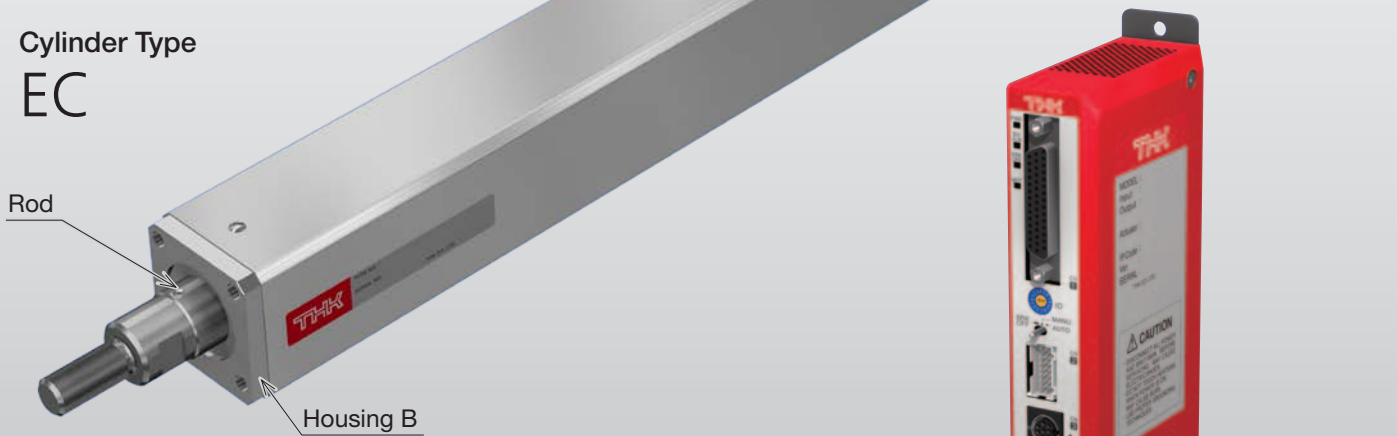

Stepper Driver Controller
TSC



Features

Compact and reliable

By incorporating an LM Guide within its rectilinear guide, the ES provides both compactness and reliability.

Reasonably priced

The use of LM Guides reduces the number of components required, making the ES available at a reasonable cost.

Long-term maintenance-free operation

The ES incorporates the model SRS LM Guide, equipped with ball retainers, as well as Lubricator QZ, for optimal ball-screw lubrication. The combined effect provides for long-term maintenance-free operation.

Predictable service life

The service life of the LM Guide and ball screw can be calculated based on usage conditions. Contact THK for details.

System

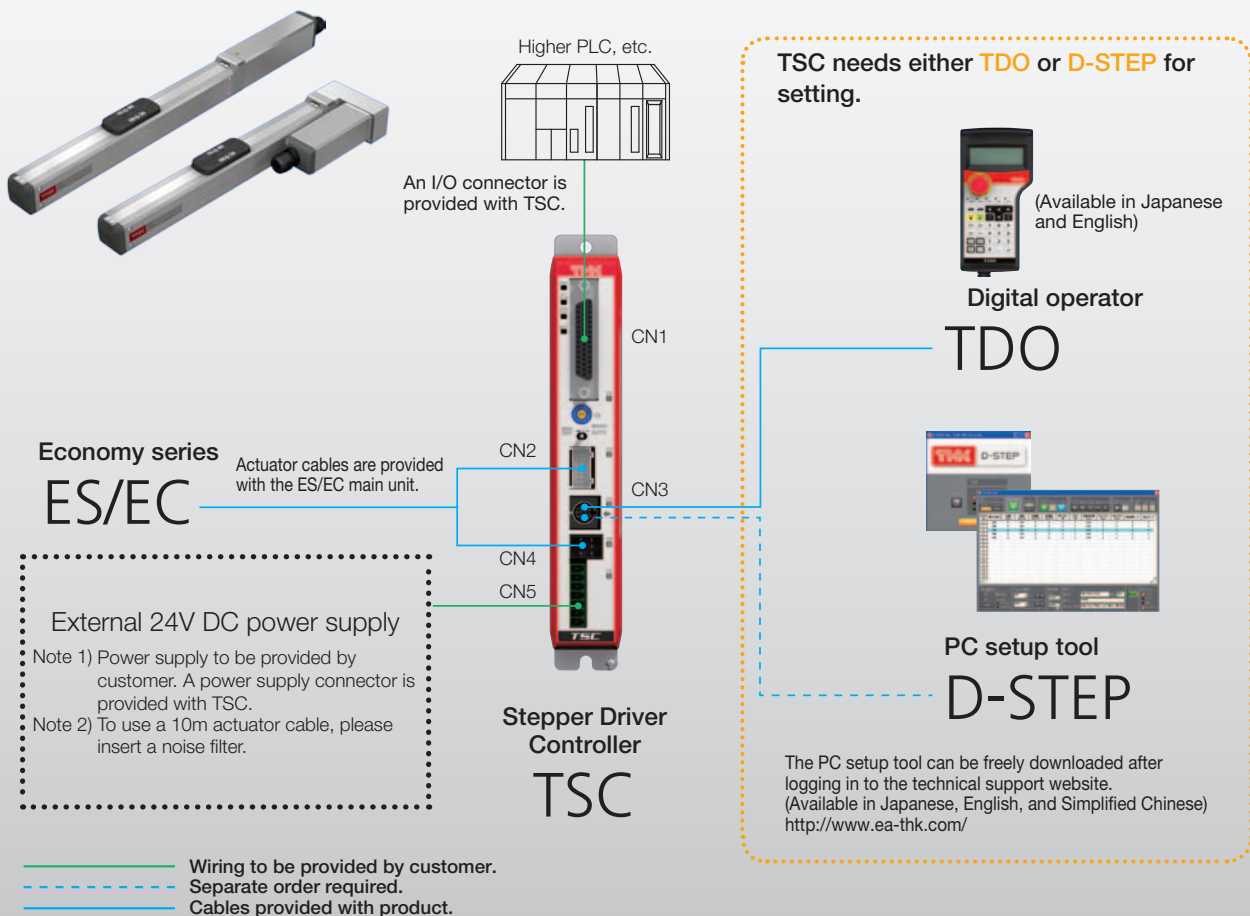

Types and Models

[Slider type]



[Cylinder type]



Series List (Stepper Driver Controller TSC Specification)

Model	Ball screw lead [mm]	Stroke [mm]	Motor type	Maximum load capacity *1 *2 [kg]	
				Horizontal mount	Vertical mount
ES3	6	50 - 300	Stepper motor □28	1	0.5
ES4	6	50 - 400	Stepper motor □35	9	4
	12			7.5	1.5
ES5	6	50 - 500	Stepper motor □42	10	5
	12			6	2
ES6	6	50 - 600	Stepper motor □42	10	5
	12			6	2
ES3R	6	50 - 300	Stepper motor □28	1	0.5
ES4R	6	50 - 400	Stepper motor □35	4	1.5
	12			2	1
ES5R	6	50 - 500	Stepper motor □42	8	2
	12			6	1
ES6R	6	50 - 600	Stepper motor □42	8	2
	12			6	1
EC3	6	50 - 200	Stepper motor □35	15	6
EC4	6	50 - 300	Stepper motor □42	40	12
	12			25	4.5
EC3R	6	50 - 200	Stepper motor □35	15	3
EC4R	6	50 - 300	Stepper motor □42	40	6
	12			15	4
EC3H	6	50 - 200	Stepper motor □35	15	6
EC4H	6	50 - 300	Stepper motor □42	40	12
	12			25	4.5

*1 This specification shows the values when combining with stepper driver controller TSC.

*2 Load capacity and maximum speed vary dependent on usage conditions. For details, see "Speed and Load Capacity".

*3 Horizontal: 460, Vertical: 450

[Cylinder type/with linear bush]

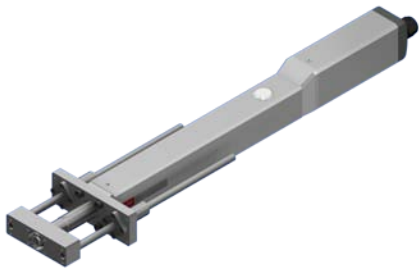

Maximum speed for each stroke *1 *2 [mm/s]												
Stroke [mm]												
50	100	150	200	250	300	350	400	450	500	550	600	
300												
250												
500												
300												
500												
300										270	230	
500												460
300												
250												
Horizontal: 500, Vertical: 440												
Horizontal: 300, Vertical: 250												
500												
250												230
Horizontal: 500, Vertical: 450												★3
187												
Horizontal: 250, Vertical: 240				230	170							
450					340							
187												
250				230	170							
Horizontal: 400, Vertical: 370					340							
187												
Horizontal: 250, Vertical: 240				230	170							
450					340							

Model Configuration

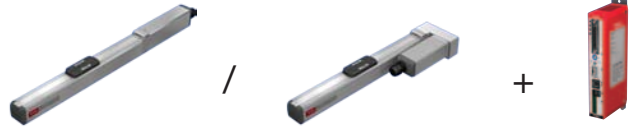

ES/EC (type with motor)

Model	Ball screw lead	Stroke	Design symbol	Control device	Option	Motor used	Motor cable orientation	Home position	Cable Length
ES5R	06	0150	B	TL	MR-GR	M05	L	D00	F3
(1)	(2)	(3)	(4)	(5)	(6)	(7)	(8)	(9)	(10)
ES3	06: 6mm	0050: 50mm	B	TS: Stepper driver controller TSC Separate order required.	No symbol: None	28P: Stepper motor □28	No symbol: When selecting TSC	D00: Motor side	No symbol: None
ES4	12: 12mm	0100: 100mm			MR: Motor right-turn folded ^{*1}	35P: Stepper motor □35	R: Right	R00: Reverse motor side	S3: Standard 3m
ES5		0150: 150mm			ML: Motor left-turn folded ^{*1}	42P: Stepper motor □42	U: Up		S5: Standard 5m
ES6		0200: 200mm			GR: Change the cover color to gray ^{*2}	28PB: Stepper motor □28 with brake	L: Left		SA: Standard 10m
ES3R		0250: 250mm			SB: With slider base ^{*2}	35PB: Stepper motor □35 with brake	D: Down		
ES4R		0300: 300mm			CB: With cylinder base ^{*3}	42PB: Stepper motor □42 with brake			
ES5R		0350: 350mm			FL: With flange ^{*3 *4}				
ES6R		0400: 400mm			LB: With link ball ^{*3 *4}				
EC3		0450: 450mm			□ ₁ □ ₂ : Sensor ^{*2}				
EC4		0500: 500mm							
EC3R		0550: 550mm							
EC4R		0600: 600mm							
EC3H									
EC4H									

R represents motor return, and H represents "with linear bush".

For ES3, ES3R, EC3, EC3R and EC3H, only ball screw lead 6 is applicable.

Maximum stroke differs depending on models.
 ES3: 300mm
 ES4: 400mm
 ES5: 500mm
 ES6: 600mm
 EC3: 200mm
 EC4: 300mm

Change the cover color to gray
 You can change the color of motor end cover and housing cover to gray.
 Standard: red
 selected: gray
 When GR is

Motors differ depending on models.
 ES3: "28P", "28PB" EC3: "35P", "35PB"
 ES4: "35P", "35PB" EC4: "42P", "42PB"
 ES5: "42P", "42PB"
 ES6: "42P", "42PB"

*1 This is valid only when selecting ES□R or EC□R for model (1).
 *2 This is valid only when selecting ES for model (1).
 *3 This is valid only when selecting EC for model (1).
 *4 If you select EC□H for model (1), "FL" and "LB" cannot be selected.

ES
 If you select "MR" as an option, "R", "U" and "D" cannot be selected.
 If you select "ML" as an option, "L", "U" and "D" cannot be selected.
 EC
 If you select "MR" as an option, "R" cannot be selected.
 If you select "ML" as an option, "L" cannot be selected.

Motor wrap direction

Slider type ES

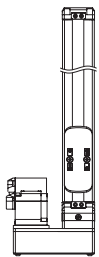

Option symbol ML: Left-turn folded

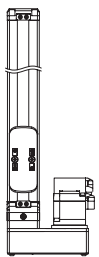

Option symbol MR: Right-turn folded

Cylinder type EC

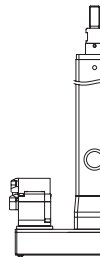

Option symbol ML: Left-turn folded

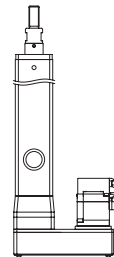

Option symbol MR: Right-turn folded

Pages for detailed description

(6) Options	GR: Change the cover color to gray	P. 21
	SB: With slider base	P. 22
	CB: With cylinder base	P. 26
	FL: With flange	P. 26
	LB: With link ball	P. 26
	□ ₁ □ ₂ : Sensor	P. 24

Pressing Force and Pressing Set Value: Relationship Diagram

Pressing force may vary depending on the pressing set value. For the mounting method, see .

■ ES3/ES3R

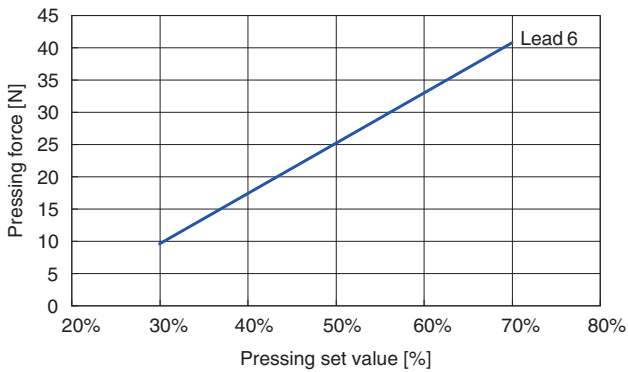

■ EC3/EC3R

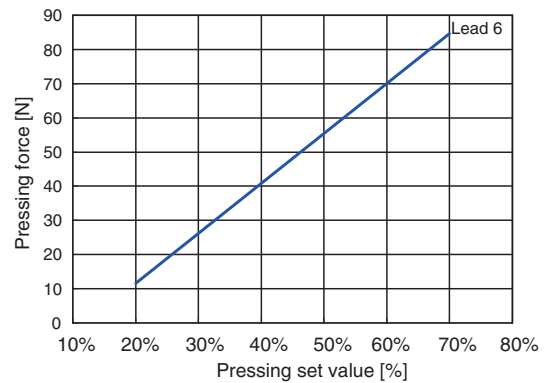

■ ES4/ES4R

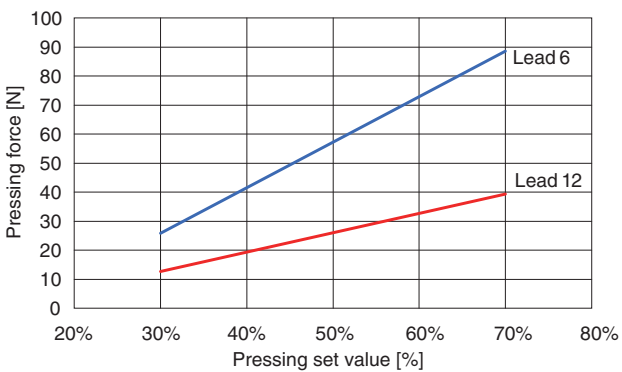

■ EC4/EC4R

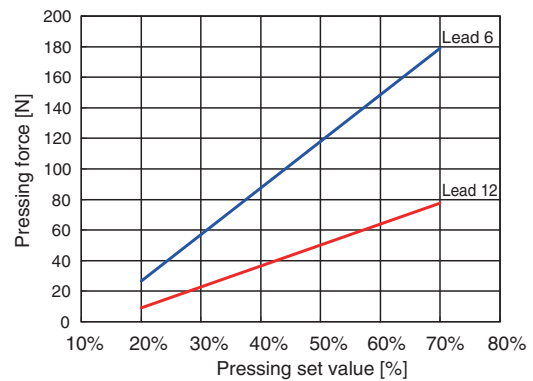

■ ES5/ES5R

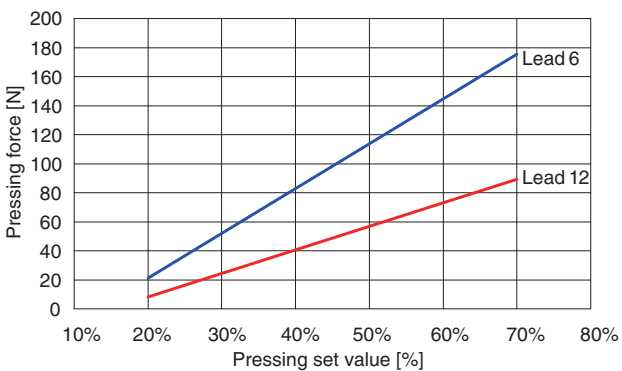

■ ES6/ES6R

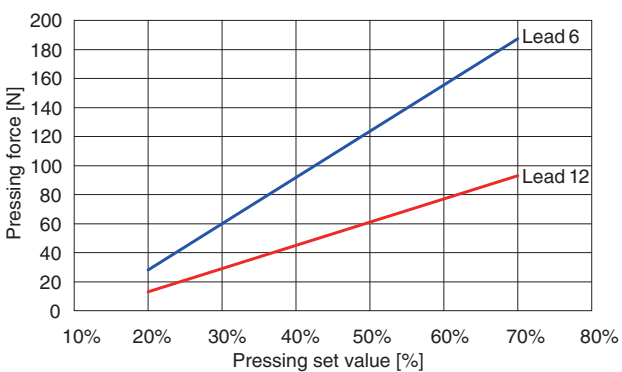

ES3 Slider type TSC specification Direct motor coupling



Model Configuration

Model	Ball screw lead	Stroke	Design symbol	Control device Type	Option	Motor used	Home position	Cable length
ES3	06	0150	B	TS	GR-SB	28P	D00	S3

ES3	06: 6mm	0050: 50mm to 0300: 300mm	B	TS: TSC	No symbol: None GR : Change the cover color to gray SB : With slider base □₁□₂: Sensors	28P: □28 28PB: □28 with brake	D00: Motor side R00: Reverse motor side	No symbol: None S3 : Standard 3m S5 : Standard 5m SA*: Standard 10m
------------	----------------	---	----------	----------------	--	--	--	--

* To select SA, insert a noise filter to the TSC power supply.
Recommended noise filter is *RSAN-2003 (TDK-Lambda Corporation).

Basic Specifications

Control device type		TSC	
Motor		□28	
Ball screw lead [mm]		6	
Maximum load	Acceleration and deceleration rate	Horizontal mount	0.3G
	Weight [kg]	Vertical	0.2G
Running life *1 [km]		5000	
Positioning repeatability [mm]		±0.020	
Lost motion [mm]		0.1	
Static permissible moment **2 [N·m]		M _A : 6.0, M _B : 7.5, M _C : 5.9	

*1 Service life is based on below conditions.

Conditions: Horizontal or vertical, under the maximum load capacity, overhang length A=6mm, B and C=0mm, 0.3G for horizontal, 0.2G for vertical, stroke 50mm

*2 Maximum permissible moment when unit is stationary.

Applied point of moment load for MA and MC are the top face of the table, and that for MB is the center of the table.

Static Permissible Moment

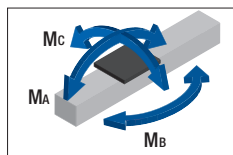

Speed and Load Capacity: Relationship Diagram

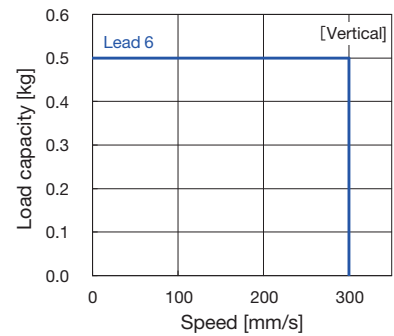
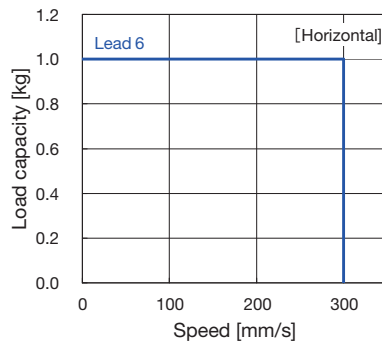

Permissible Overhang Length *

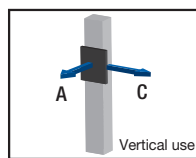
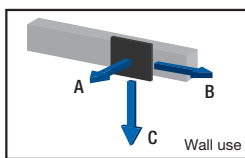
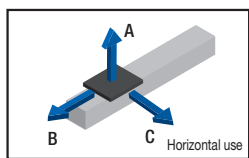

Horizontal mount [mm]				
Ball screw lead [mm]	Load mass [kg]	A	B	C
6	0.5	200	200	200
	1	200	160	200

Wall mount [mm]				
Ball screw lead [mm]	Load mass [kg]	A	B	C
6	0.5	200	200	200
	1	170	150	200

Vertical mount [mm]			
Ball screw lead [mm]	Load mass [kg]	A	C
6	0.3	200	200
	0.5	200	200

* Distance from the center of the top face of the table to the load center of gravity position under the following conditions: 5,000km running life, single-direction load, 0.3G horizontal, 0.2G vertical, 150mm stroke.

ES3 + TSC



Dimensions

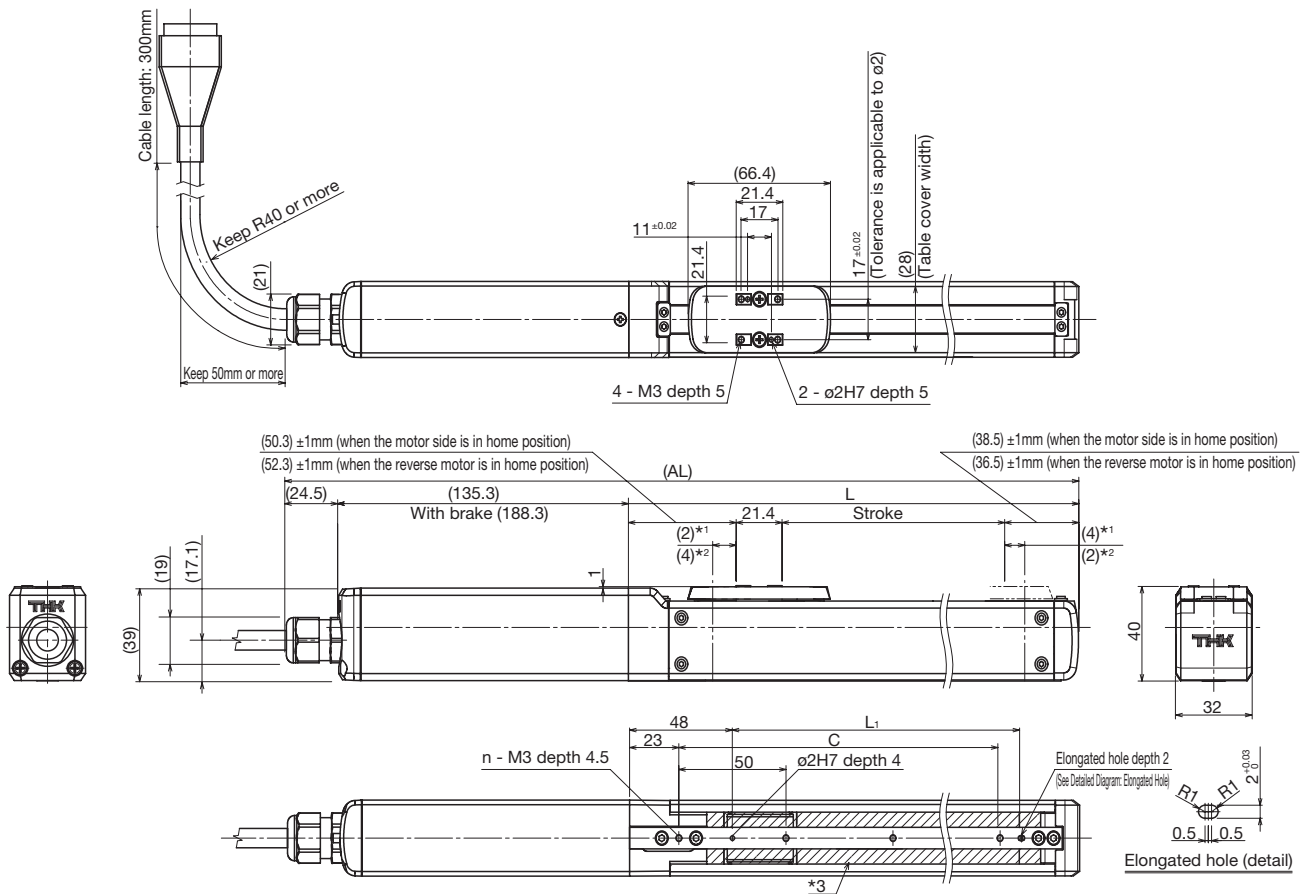

- *1 Stroke to the mechanical stopper when the motor side is in home position.
- *2 Stroke to the mechanical stopper when the reverse motor side is in home position.
- *3 represents the opening parts.

Stroke [mm] (Stroke between mechanical stoppers)		50 (56)	100 (106)	150 (156)	200 (206)	250 (256)	300 (306)
Maximum speed ^{*1 *2} [mm/s]	Ball screw lead: 6mm	300					
Dimensions [mm]	AL ^{*3}	320 (373)	370 (423)	420 (473)	470 (523)	520 (573)	570 (623)
	L	160.2	210.2	260.2	310.2	360.2	410.2
	L ₁	85	135	185	235	285	335
	C	100	150	200	250	300	350
Mounting hole count	n	3	4	5	6	7	8
Weight ^{*3} [kg]		1 (1.3)	1 (1.4)	1.1 (1.4)	1.1 (1.5)	1.3 (1.5)	1.3 (1.6)

*1 Load capacity and maximum speed vary dependent on usage conditions. For details, see "Speed and Load Capacity".

*2 Dependent on permissible rotational speed of ball screw.

*3 Values when a brake is installed are shown in parentheses.

ES3R

Slider type TSC specification Motor wrap



Model Configuration

Model	Ball screw lead	Stroke	Design symbol	Control device Type	Option	Motor used	Home position	Cable length
ES3R	06	0150	B	TS	MR-GR	28P	D00	S3
ES3R	06: 6mm	0050: 50mm to 0300: 300mm	B	TS: TSC	MR: Motor right-turn folded ML: Motor left-turn folded GR: Change the cover color to gray SB: With slider base <input type="checkbox"/> 1 <input type="checkbox"/> 2: Sensors	28P: <input type="checkbox"/> 28 28PB: <input type="checkbox"/> 28 with brake	D00: Motor side R00: Reverse motor side	No symbol: None S3: Standard 3m S5: Standard 5m SA*: Standard 10m

* To select SA, insert a noise filter to the TSC power supply.
Recommended noise filter is "RSAN-2003 (TDK-Lambda Corporation)".

Basic Specifications

Control device type		TSC	
Motor		<input type="checkbox"/> 28	
Ball screw lead [mm]		6	
Maximum load	Acceleration and deceleration rate	Horizontal mount	0.3G
	Weight [kg]	Vertical	0.2G
Running life *1 [km]		5000	
Positioning repeatability [mm]		±0.020	
Lost motion [mm]		0.1	
Static permissible moment **2 [N·m]		MA: 6.0, MA: 7.5, MC: 5.9	

*1 Service life is based on below conditions.

Conditions: Horizontal or vertical, under the maximum load capacity, overhang length A=6mm, B and C=0mm, 0.3G for horizontal, 0.2G for vertical, stroke 50mm

*2 Maximum permissible moment when unit is stationary.

Applied point of moment load for MA and MC are the top face of the table, and that for MB is the center of the table.

Static Permissible Moment

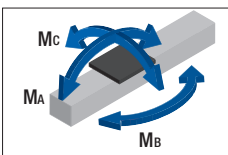

Speed and Load Capacity: Relationship Diagram

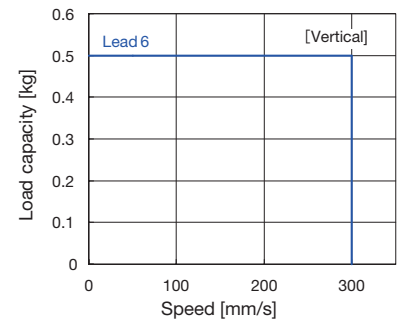
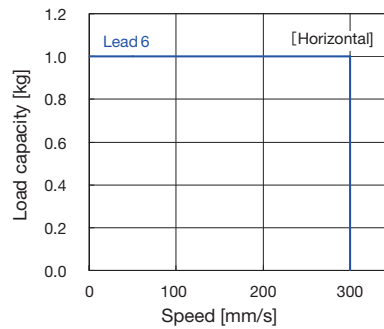

Permissible Overhang Length *

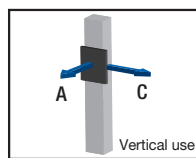
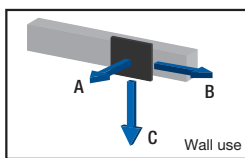
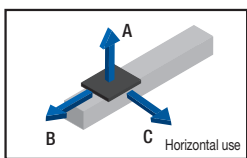

Horizontal mount [mm]				
Ball screw lead [mm]	Load mass [kg]	A	B	C
6	0.5	200	200	200
	1	200	160	200

Wall mount [mm]				
Ball screw lead [mm]	Load mass [kg]	A	B	C
6	0.5	200	200	200
	1	170	150	200

Vertical mount [mm]			
Ball screw lead [mm]	Load mass [kg]	A	C
6	0.3	200	200
	0.5	200	200

* Distance from the center of the top face of the table to the load center of gravity position under the following conditions: 5,000km running life, single-direction load, 0.3G horizontal, 0.2G vertical, 150mm stroke.

ES3R + TSC



Dimensions

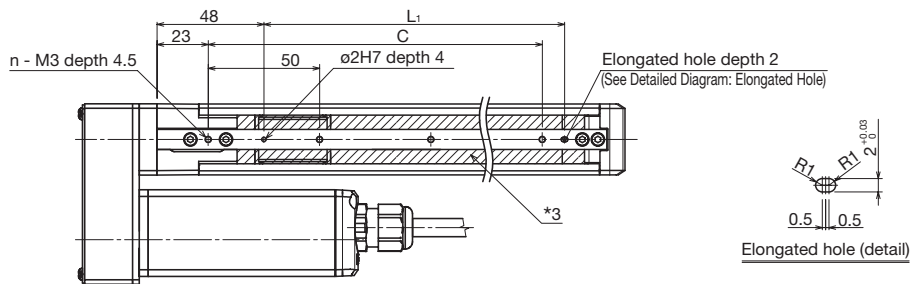
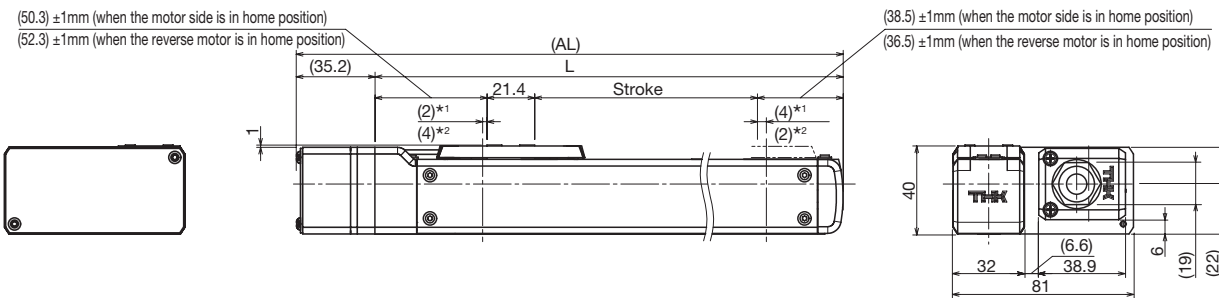
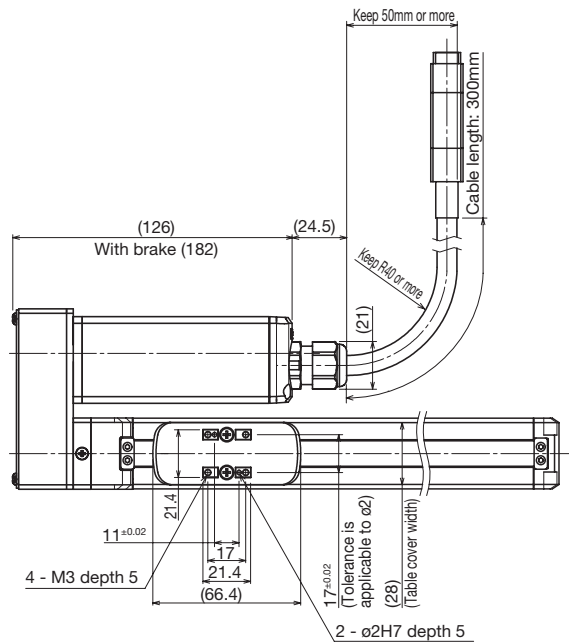

- *1 Stroke to the mechanical stopper when the motor side is in home position.
- *2 Stroke to the mechanical stopper when the reverse motor side is in home position.
- *3 represents the opening parts.

Stroke [mm] (Stroke between mechanical stoppers)		50 (56)	100 (106)	150 (156)	200 (206)	250 (256)	300 (306)
Maximum speed *1 *2 [mm/s]	Ball screw lead: 6mm	300					
Dimensions [mm]	AL	195.4	245.4	295.4	345.4	395.4	445.4
	L	160.2	210.2	260.2	310.2	360.2	410.2
	L ₁	85	135	185	235	285	335
	C	100	150	200	250	300	350
Mounting hole count	n	3	4	5	6	7	8
Weight *3 [kg]		1 (1.3)	1.1 (1.3)	1.1 (1.4)	1.2 (1.5)	1.3 (1.5)	1.3 (1.6)

*1 Load capacity and maximum speed vary dependent on usage conditions. For details, see "Speed and Load Capacity".

*2 Dependent on permissible rotational speed of ball screw.

*3 Values when a brake is installed are shown in parentheses.

ES4

Slider type TSC specification Direct motor coupling



Model Configuration

Model	Ball screw lead	Stroke	Design symbol	Control device Type	Option	Motor used	Home position	Cable length
ES4	06	0150	B	TS	GR-SB	35P	D00	S3
ES4	06: 6mm 12: 12mm	0050: 50mm to 0400: 400mm	B	TS: TSC	No symbol: None GR : Change the cover color to gray SB : With slider base □ ₁ □ ₂ : Sensors	35P: □35 35PB: □35 with brake	D00: Motor side R00: Reverse motor side	No symbol: None S3 : Standard 3m S5 : Standard 5m SA*: Standard 10m

* To select SA, insert a noise filter to the TSC power supply. Recommended noise filter is "RSAN-2003 (TDK-Lambda Corporation)".

Basic Specifications

Control device type		TSC	
Motor		□35	
Ball screw lead [mm]		6	12
Maximum load	Acceleration and deceleration rate	0.3G	0.2G
	Horizontal mount	9	7.5
Weight [kg]	Vertical	4	1.5
	Vertical	4	1.5
Running life *1 [km]		5000	
Positioning repeatability [mm]		±0.020	
Lost motion [mm]		0.1	
Static permissible moment ** [N·m]		M _A : 9.3, M _B : 13.5, M _C : 17.7	

*1 Service life is based on below conditions.

Conditions: Horizontal or vertical, under the maximum load capacity, overhang length A=6mm, B and C=0mm, 0.3G for horizontal, 0.2G for vertical, stroke 50mm

*2 Maximum permissible moment when unit is stationary.

Applied point of moment load for MA and MC are the top face of the table, and that for MB is the center of the table.

Static Permissible Moment

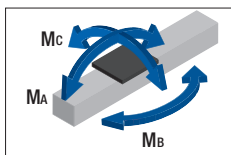

Speed and Load Capacity: Relationship Diagram

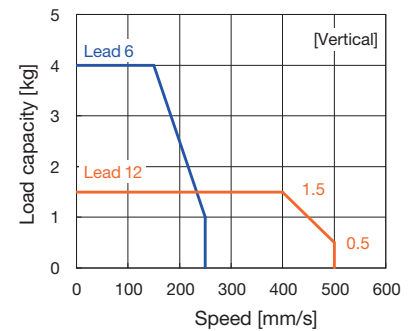
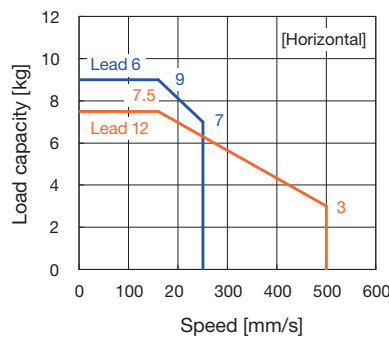

Permissible Overhang Length *

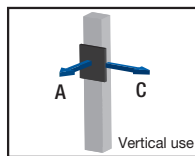
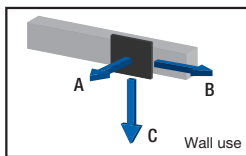
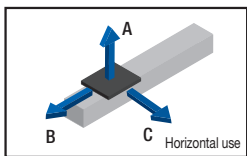

Horizontal mount [mm]					Wall mount [mm]					Vertical mount [mm]			
Ball screw lead [mm]	Load mass [kg]	A	B	C	Ball screw lead [mm]	Load mass [kg]	A	B	C	Ball screw lead [mm]	Load mass [kg]	A	C
6	4.5	300	50	100	6	4.5	60	30	300	6	2	100	110
	9	160	20	40		9	10	5	70		4	30	40
12	3.8	260	60	100	12	3.8	70	40	220	12	0.8	260	300
	7.5	110	20	40		7.5	10	10	50		1.5	130	150

* Distance from the center of the top face of the table to the load center of gravity position under the following conditions: 5,000km running life, single-direction load, 0.3G horizontal, 0.2G vertical, 150mm stroke.

ES4 + TSC



Dimensions

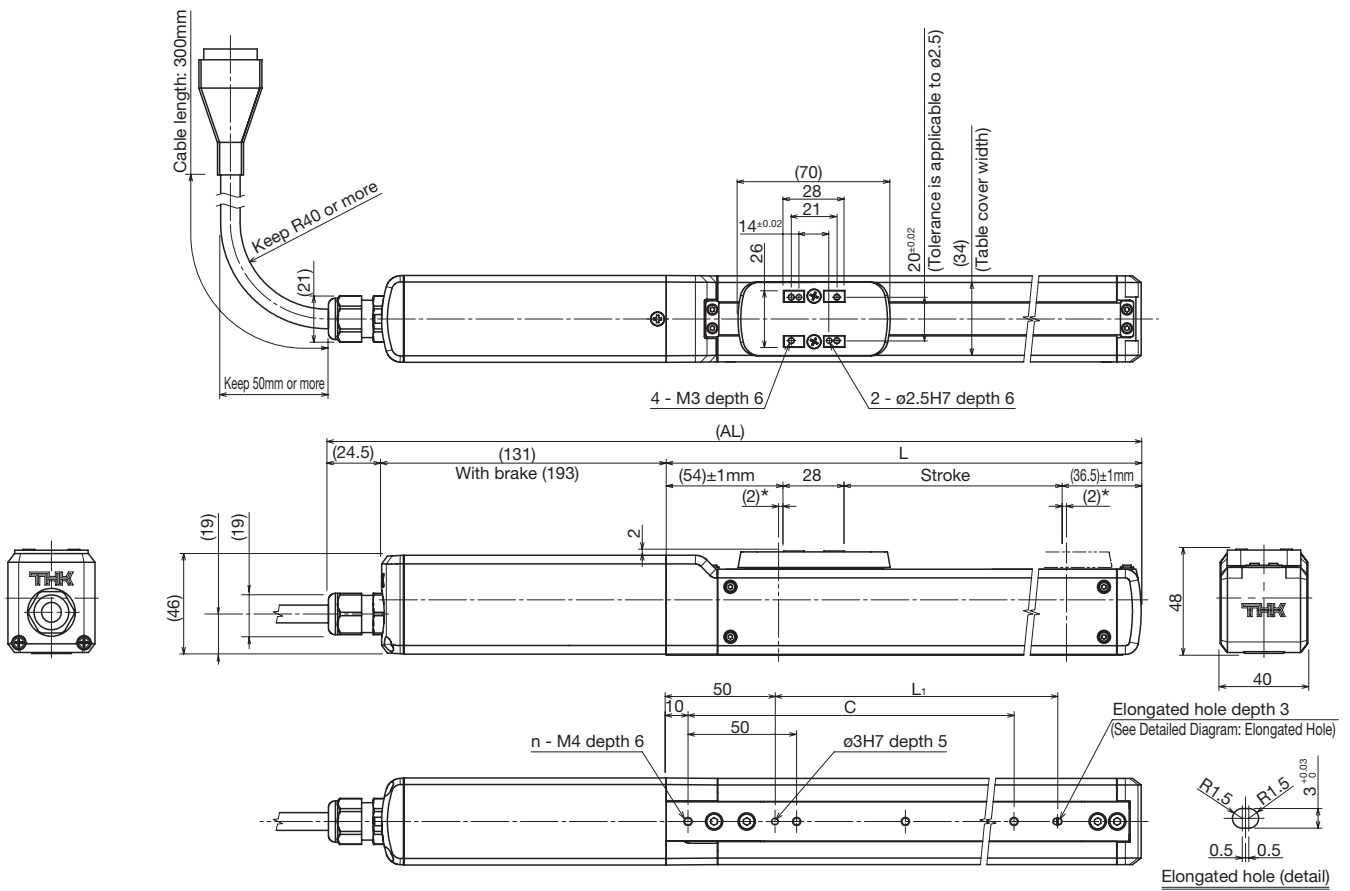

* This is a stroke between mechanical stoppers.

Stroke [mm] (Stroke between mechanical stoppers)	50 (54)	100 (104)	150 (154)	200 (204)	250 (254)	300 (304)	350 (354)	400 (404)	
Maximum speed ^{*1 *2} [mm/s]	Ball screw lead: 6mm	250							
	Ball screw lead: 12mm	500							
Dimensions [mm]	AL ^{*3}	324 (386)	374 (436)	424 (486)	474 (536)	524 (586)	574 (636)	624 (686)	674 (736)
	L	168.5	218.5	268.5	318.5	368.5	418.5	468.5	518.5
	L ₁	80	130	180	230	280	330	380	430
	C	100	150	200	250	300	350	400	450
Mounting hole count	n	3	4	5	6	7	8	9	10
Weight ^{*3} [kg]	1.5 (1.9)	1.6 (2.1)	1.7 (2.2)	1.8 (2.3)	1.9 (2.4)	2 (2.5)	2.1 (2.6)	2.2 (2.7)	

*1 Load capacity and maximum speed vary dependent on usage conditions. For details, see "Speed and Load Capacity".

*2 Dependent on permissible rotational speed of ball screw.

*3 Values when a brake is installed are shown in parentheses.

ES4R

Slider type TSC specification Motor wrap



Model Configuration

Model	Ball screw lead	Stroke	Design symbol	Control device Type	Option	Motor used	Home position	Cable length
ES4R	06	0150	B	TS	MR-GR	35P	D00	S3
ES4R	06: 6mm 12: 12mm	0050: 50mm to 0400: 400mm	B	TS: TSC	MR: Motor right-turn folded ML: Motor left-turn folded GR: Change the cover color to gray SB: With slider base <input type="checkbox"/> 1 <input type="checkbox"/> 2: Sensors	35P: <input type="checkbox"/> 35 35PB: <input type="checkbox"/> 35 with brake	D00: Motor side R00: Reverse motor side	No symbol: None S3: Standard 3m S5: Standard 5m SA*: Standard 10m

* To select SA, insert a noise filter to the TSC power supply. Recommended noise filter is "RSAN-2003 (TDK-Lambda Corporation)".

Basic Specifications

Control device type		TSC	
Motor		<input type="checkbox"/> 35	
Ball screw lead [mm]		6	12
Maximum load	Acceleration and deceleration rate	0.3G	4
	Horizontal mount	0.2G	2
Weight [kg]	Vertical	1.5	1
	Vertical	0.2G	1
Running life *1 [km]		5000	
Positioning repeatability [mm]		±0.020	
Lost motion [mm]		0.1	
Static permissible moment **2 [N·m]		M _A : 9.3, M _B : 13.5, M _C : 17.7	

*1 Service life is based on below conditions.

Conditions: Horizontal or vertical, under the maximum load capacity, overhang length A=6mm, B and C=0mm, 0.3G for horizontal, 0.2G for vertical, stroke 50mm

*2 Maximum permissible moment when unit is stationary.

Applied point of moment load for MA and MC are the top face of the table, and that for MB is the center of the table.

Static Permissible Moment

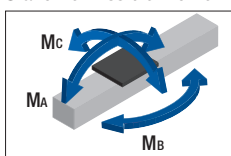

Speed and Load Capacity: Relationship Diagram

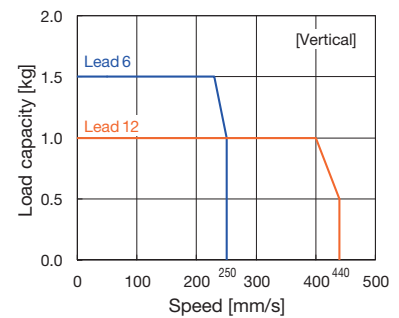
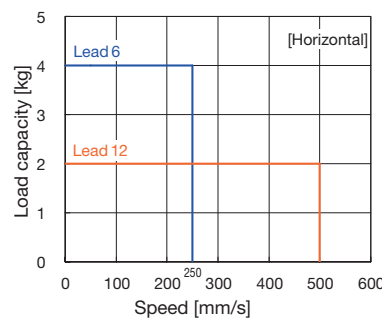

Permissible Overhang Length *

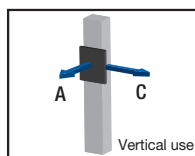
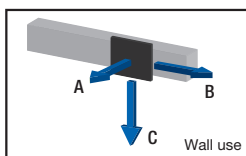
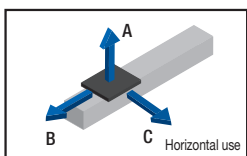

Horizontal mount [mm]				
Ball screw lead [mm]	Load mass [kg]	A	B	C
6	2	300	120	240
	4	300	50	110
12	1	300	240	300
	2	300	120	200

Wall mount [mm]				
Ball screw lead [mm]	Load mass [kg]	A	B	C
6	2	210	110	300
	4	80	40	300
12	1	300	260	300
	2	170	110	300

Vertical mount [mm]			
Ball screw lead [mm]	Load mass [kg]	A	C
6	0.8	280	300
	1.5	140	160
12	0.5	300	300
	1	210	240

* Distance from the center of the top face of the table to the load center of gravity position under the following conditions: 5,000km running life, single-direction load, 0.3G horizontal, 0.2G vertical, 150mm stroke.

ES4R + TSC



Dimensions

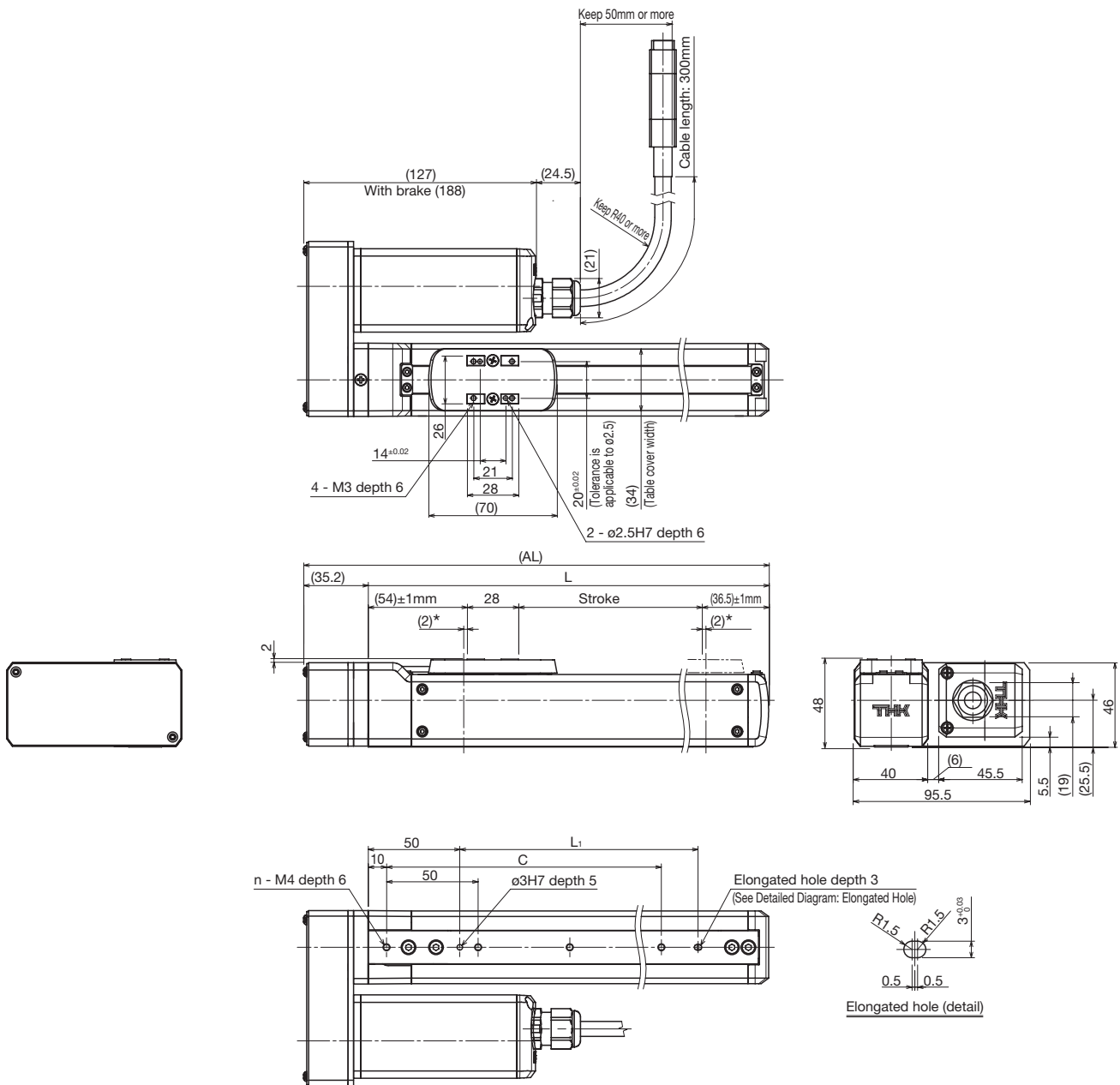

* This is a stroke between mechanical stoppers.

Stroke [mm] (Stroke between mechanical stoppers)		50 (54)	100 (104)	150 (154)	200 (204)	250 (254)	300 (304)	350 (354)	400 (404)
Maximum speed ^{*1 *2} [mm/s]	Ball screw lead: 6mm	250							
	Ball screw lead: 12mm	Horizontal: 500, Vertical: 440							
Dimensions [mm]	AL ^{*3}	203.7	253.7	303.7	353.7	403.7	453.7	503.7	553.7
	L	168.5	218.5	268.5	318.5	368.5	418.5	468.5	518.5
	L ₁	80	130	180	230	280	330	380	430
	C	100	150	200	250	300	350	400	450
Mounting hole count	n	3	4	5	6	7	8	9	10
Weight ^{*3} [kg]		1.6 (2)	1.7 (2.1)	1.8 (2.2)	1.9 (2.3)	2 (2.4)	2.1 (2.5)	2.2 (2.6)	2.3 (2.7)

^{*1} Load capacity and maximum speed vary dependent on usage conditions. For details, see "Speed and Load Capacity".

^{*2} Dependent on permissible rotational speed of ball screw.

^{*3} Values when a brake is installed are shown in parentheses.

ES5 Slider type TSC specification Direct motor coupling



Model Configuration

Model	Ball screw lead	Stroke	Design symbol	Control device Type	Option	Motor used	Home position	Cable length
ES5	06	0150	B	TS	GR-SB	42P	D00	S3
ES5	06: 6mm 12: 12mm	0050: 50mm to 0500: 500mm	B	TS: TSC	No symbol: None GR: Change the cover color to gray SB: With slider base □ ₁ □ ₂ : Sensors	42P: □42 42PB: □42 with brake	D00: Motor side R00: Reverse motor side	No symbol: None S3: Standard 3m S5: Standard 5m SA*: Standard 10m

* To select SA, insert a noise filter to the TSC power supply. Recommended noise filter is "RSAN-2003 (TDK-Lambda Corporation)".

Basic Specifications

Control device type		TSC	
Motor		□42	
Ball screw lead [mm]		6	12
Maximum load	Acceleration and deceleration rate	0.3G	10
	Horizontal mount	0.2G	6
Weight [kg]	Vertical	5	2
	Vertical	0.2G	2
Running life *1 [km]		5000	
Positioning repeatability [mm]		±0.020	
Lost motion [mm]		0.1	
Static permissible moment ** [N·m]		M _A : 10.5, M _B : 22, M _C : 22.1	

*1 Service life is based on below conditions.

Conditions: Horizontal or vertical, under the maximum load capacity, overhang length A=6mm, B and C=0mm, 0.3G for horizontal, 0.2G for vertical, stroke 50mm

*2 Maximum permissible moment when unit is stationary.

Applied point of moment load for MA and MC are the top face of the table, and that for MB is the center of the table.

Static Permissible Moment

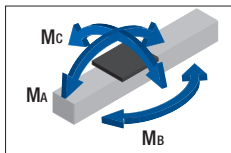

Speed and Load Capacity: Relationship Diagram

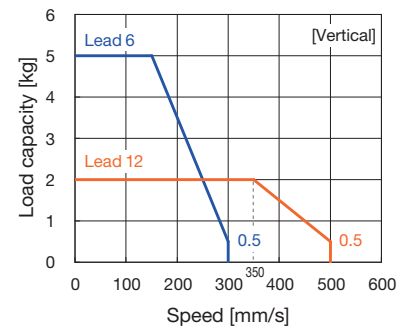
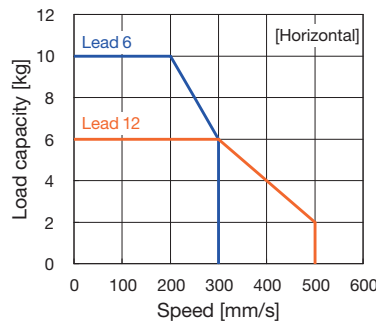

Permissible Overhang Length *

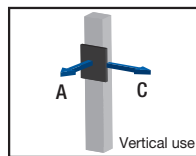
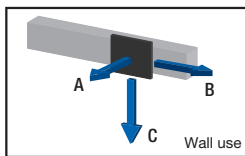
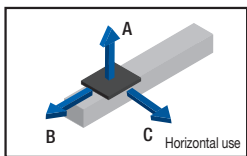

Horizontal mount [mm]				
Ball screw lead [mm]	Load mass [kg]	A	B	C
6	5	400	90	200
	10	270	40	90
12	3	400	160	280
	6	320	70	130

Wall mount [mm]				
Ball screw lead [mm]	Load mass [kg]	A	B	C
6	5	160	70	400
	10	50	20	220
12	3	260	130	400
	6	100	50	250

Vertical mount [mm]			
Ball screw lead [mm]	Load mass [kg]	A	C
6	2.5	160	160
	5	70	70
12	1	400	400
	2	200	200

* Distance from the center of the top face of the table to the load center of gravity position under the following conditions: 5,000km running life, single-direction load, 0.3G horizontal, 0.2G vertical, 150mm stroke.

ES5 + TSC



Dimensions

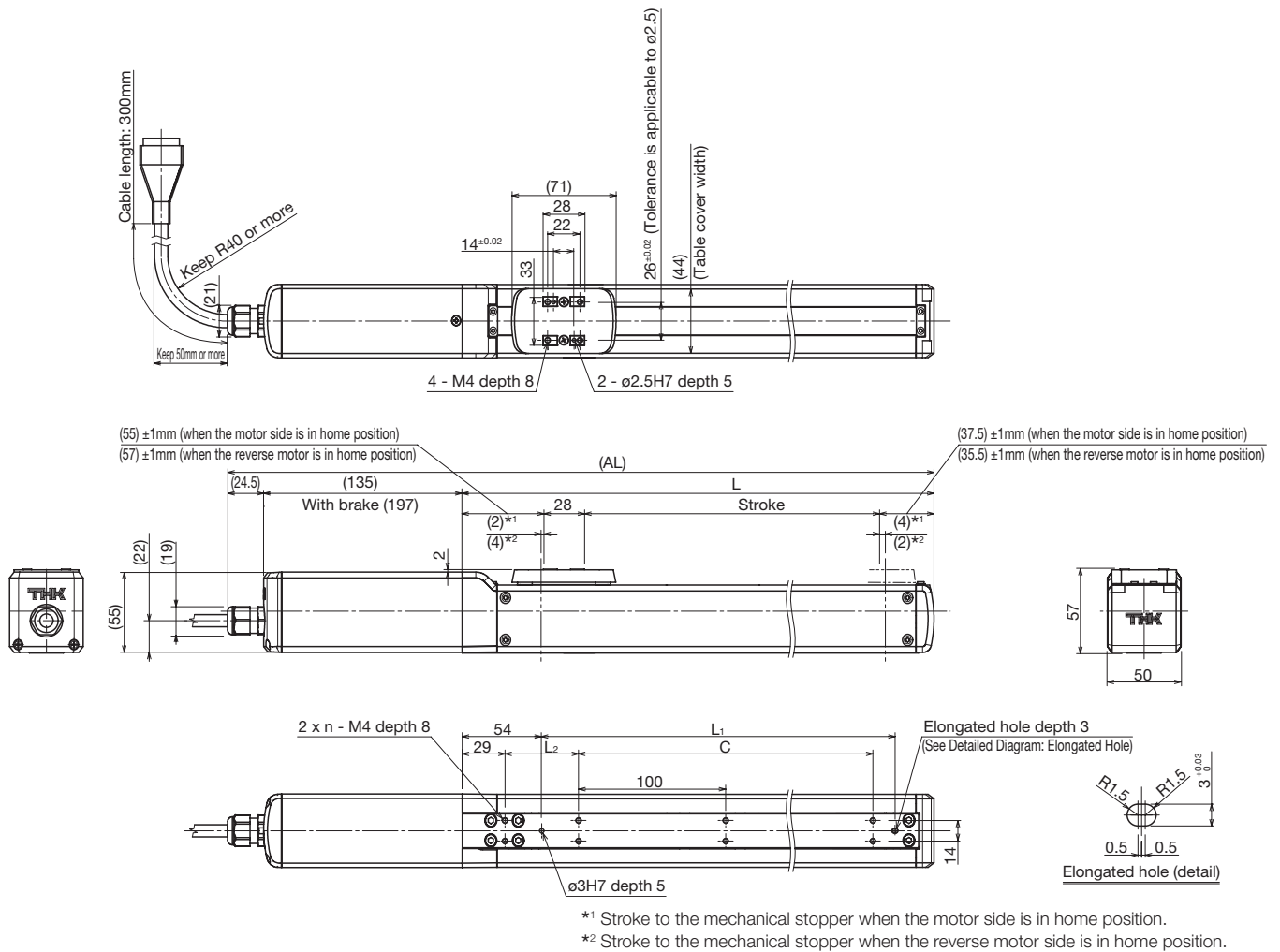

*1 Stroke to the mechanical stopper when the motor side is in home position.
 *2 Stroke to the mechanical stopper when the reverse motor side is in home position.

Stroke [mm] (Stroke between mechanical stoppers)		50 (56)	100 (106)	150 (156)	200 (206)	250 (256)	300 (306)	350 (356)	400 (406)	450 (456)	500 (506)
Maximum speed [mm/s]	Ball screw lead: 6mm	300									
	Ball screw lead: 12mm	500									
Dimensions [mm]	AL ^{*3}	330 (392)	380 (442)	430 (492)	480 (542)	530 (592)	580 (642)	630 (692)	680 (742)	730 (792)	780 (842)
	L	170.5	220.5	270.5	320.5	370.5	420.5	470.5	520.5	570.5	620.5
	L ₁	90	140	190	240	290	340	390	440	490	540
	L ₂	100	50	100	50	100	50	100	50	100	50
Mounting hole count	C	0	100	100	200	200	300	300	400	400	500
	n	2	3	3	4	4	5	5	6	6	7
Weight ^{*3} [kg]		2.1 (2.6)	2.2 (2.7)	2.3 (2.8)	2.5 (3)	2.6 (3.1)	2.8 (3.2)	2.9 (3.4)	3 (3.5)	3.2 (3.7)	3.3 (3.8)

*1 Load capacity and maximum speed vary dependent on usage conditions. For details, see "Speed and Load Capacity".

*2 Dependent on permissible rotational speed of ball screw.

*3 Values when a brake is installed are shown in parentheses.

ES5R Slider type TSC specification Motor wrap



Model Configuration

Model	Ball screw lead	Stroke	Design symbol	Control device Type	Option	Motor used	Home position	Cable length
ES5R	06	0150	B	TS	MR-GR	42P	D00	S3
ES5R	06: 6mm 12: 12mm	0050: 50mm to 0500: 500mm	B	TS: TSC	MR: Motor right-turn folded ML: Motor left-turn folded GR: Change the cover color to gray SB: With slider base <input type="checkbox"/> 1 <input type="checkbox"/> 2: Sensors	42P: <input type="checkbox"/> 42 42PB: <input type="checkbox"/> 42 with brake	D00: Motor side R00: Reverse motor side	No symbol: None S3: Standard 3m S5: Standard 5m SA*: Standard 10m

* To select SA, insert a noise filter to the TSC power supply. Recommended noise filter is "RSAN-2003 (TDK-Lambda Corporation)".

Basic Specifications

Control device type		TSC	
Motor		<input type="checkbox"/> 42	
Ball screw lead [mm]		6	12
Maximum load	Acceleration and deceleration rate	Horizontal mount	0.3G
	Vertical	0.2G	
Weight [kg]	Horizontal mount	8	6
	Vertical	2	1
Running life *1 [km]		5000	
Positioning repeatability [mm]		±0.020	
Lost motion [mm]		0.1	
Static permissible moment **2 [N·m]		Ma: 10.5, Mb: 22, Mc: 22.1	

*1 Service life is based on below conditions.

Conditions: Horizontal or vertical, under the maximum load capacity, overhang length A=6mm, B and C=0mm, 0.3G for horizontal, 0.2G for vertical, stroke 50mm

*2 Maximum permissible moment when unit is stationary.

Applied point of moment load for MA and MC are the top face of the table, and that for MB is the center of the table.

Static Permissible Moment

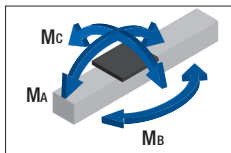

Speed and Load Capacity: Relationship Diagram

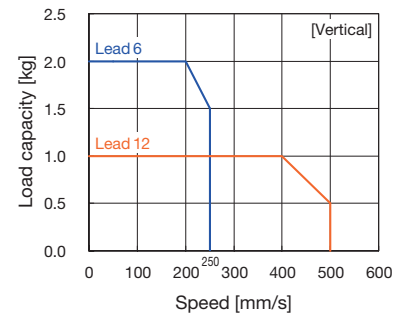
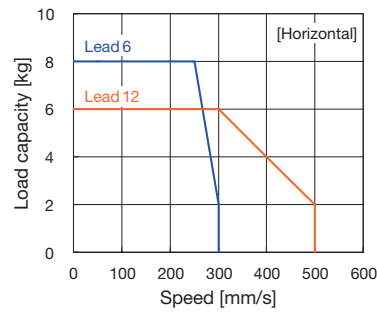

Permissible Overhang Length *

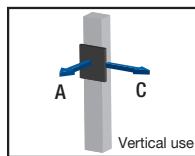
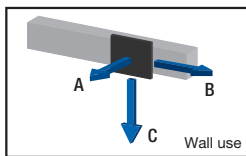
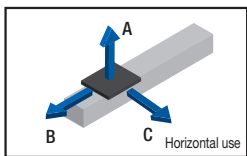

Horizontal mount [mm]					Wall mount [mm]					Vertical mount [mm]			
Ball screw lead [mm]	Load mass [kg]	A	B	C	Ball screw lead [mm]	Load mass [kg]	A	B	C	Ball screw lead [mm]	Load mass [kg]	A	C
6	4	400	110	260	6	4	220	90	400	6	1	400	400
	8	340	50	120		8	80	30	320		2	210	210
12	3	400	160	280	12	3	260	130	400	12	0.5	400	400
	6	320	70	130		6	100	50	250		1	400	400

* Distance from the center of the top face of the table to the load center of gravity position under the following conditions: 5,000km running life, single-direction load, 0.3G horizontal, 0.2G vertical, 150mm stroke.

ES5R + TSC



Dimensions

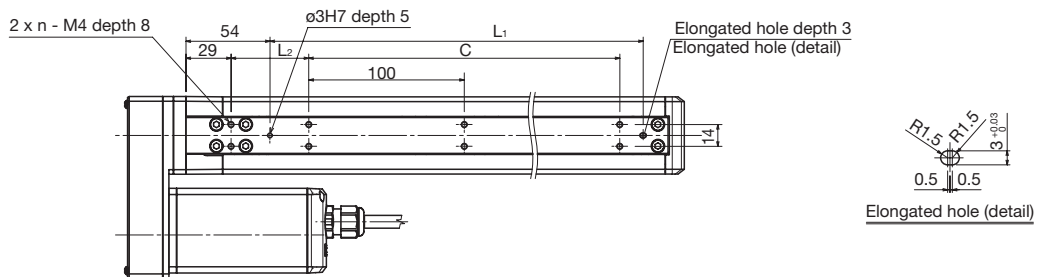
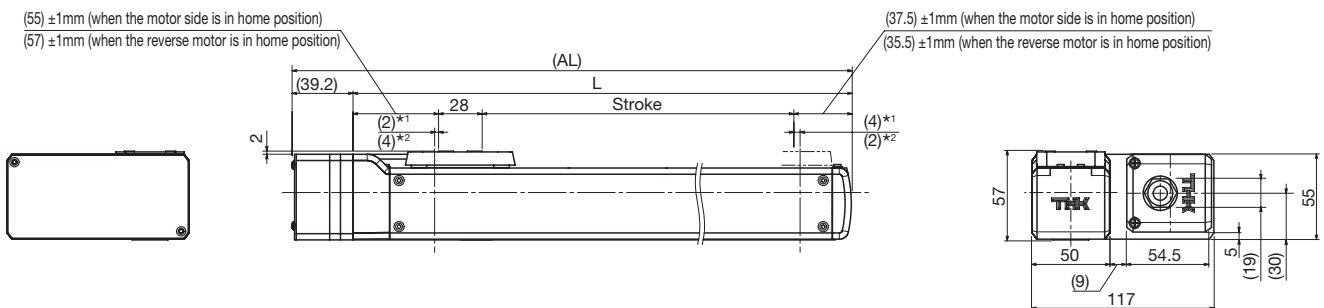
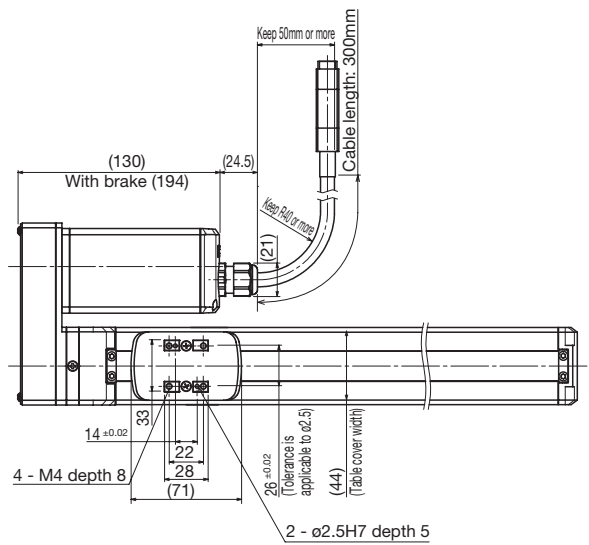

*1 Stroke to the mechanical stopper when the motor side is in home position.
 *2 Stroke to the mechanical stopper when the reverse motor side is in home position.

Stroke [mm] (Stroke between mechanical stoppers)		50 (56)	100 (106)	150 (156)	200 (206)	250 (256)	300 (306)	350 (356)	400 (406)	450 (456)	500 (506)
Maximum speed *1 *2 [mm/s]	Ball screw lead: 6mm	Horizontal: 300, Vertical: 250									
	Ball screw lead: 12mm	500									
Dimensions [mm]	AL	209.7	259.7	309.7	359.7	409.7	459.7	509.7	559.7	609.7	659.7
	L	170.5	220.5	270.5	320.5	370.5	420.5	470.5	520.5	570.5	620.5
	L ₁	90	140	190	240	290	340	390	440	490	540
	L ₂	100	50	100	50	100	50	100	50	100	50
Mounting hole count	C	0	100	100	200	200	300	300	400	400	500
	n	2	3	3	4	4	5	5	6	6	7
Weight *3 [kg]		2.2 (2.8)	2.3 (2.9)	2.4 (3)	2.6 (3.2)	2.7 (3.3)	2.8 (3.5)	3 (3.6)	3.1 (3.8)	3.3 (3.9)	3.4 (4)

*1 Load capacity and maximum speed vary dependent on usage conditions. For details, see "Speed and Load Capacity".
 *2 Dependent on permissible rotational speed of ball screw.
 *3 Values when a brake is installed are shown in parentheses.

ES6

Slider type TSC specification Direct motor coupling



Model Configuration

Model	Ball screw lead	Stroke	Design symbol	Control device Type	Option	Motor used	Home position	Cable length
ES6	06	0150	B	TS	GR-SB	42P	D00	S3
ES6	06: 6mm 12: 12mm	0050: 50mm to 0600: 600mm	B	TS: TSC	No symbol: None GR: Change the cover color to gray SB: With slider base □ ₁ □ ₂ : Sensors	42P: □42 42PB: □42 with brake	D00: Motor side R00: Reverse motor side	No symbol: None S3: Standard 3m S5: Standard 5m SA*: Standard 10m

* To select SA, insert a noise filter to the TSC power supply. Recommended noise filter is "RSAN-2003 (TDK-Lambda Corporation)".

Basic Specifications

Control device type		TSC	
Motor		□42	
Ball screw lead [mm]		6	12
Maximum load	Acceleration and deceleration rate	Horizontal mount	0.3G
	Vertical	0.2G	
Weight [kg]	Horizontal mount	10	6
	Vertical	5	2
Running life *1 [km]		5000	
Positioning repeatability [mm]		±0.020	
Lost motion [mm]		0.1	
Static permissible moment *2 [N·m]		M _A : 10.5, M _B : 22, M _C : 22.1	

*1 Service life is based on below conditions.

Conditions: Horizontal or vertical, under the maximum load capacity, overhang length A=6mm, B and C=0mm, 0.3G for horizontal, 0.2G for vertical, stroke 50mm

*2 Maximum permissible moment when unit is stationary.

Applied point of moment load for MA and MC are the top face of the table, and that for MB is the center of the table.

Static Permissible Moment

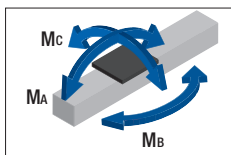

Speed and Load Capacity: Relationship Diagram

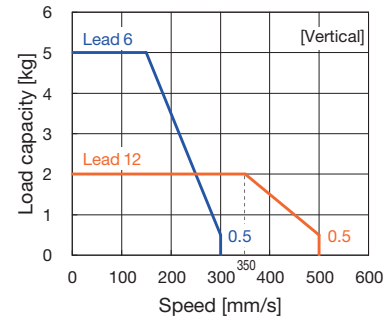
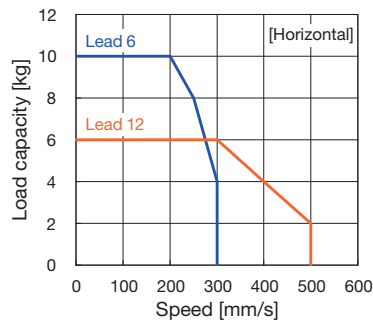

Permissible Overhang Length *

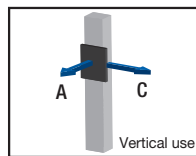
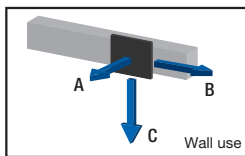
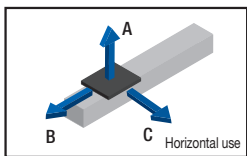

Horizontal mount [mm]					Wall mount [mm]					Vertical mount [mm]			
Ball screw lead [mm]	Load mass [kg]	A	B	C	Ball screw lead [mm]	Load mass [kg]	A	B	C	Ball screw lead [mm]	Load mass [kg]	A	C
6	5	500	90	200	6	5	160	70	500	6	2.5	160	160
	10	260	40	90		10	40	20	210		5	60	60
	3	500	160	280		3	250	130	500		1	420	420
12	6	320	70	130	12	6	90	50	240	12	2	190	190

* Distance from the center of the top face of the table to the load center of gravity position under the following conditions: 5,000km running life, single-direction load, 0.3G horizontal, 0.2G vertical, 150mm stroke.

ES6 + TSC



Dimensions

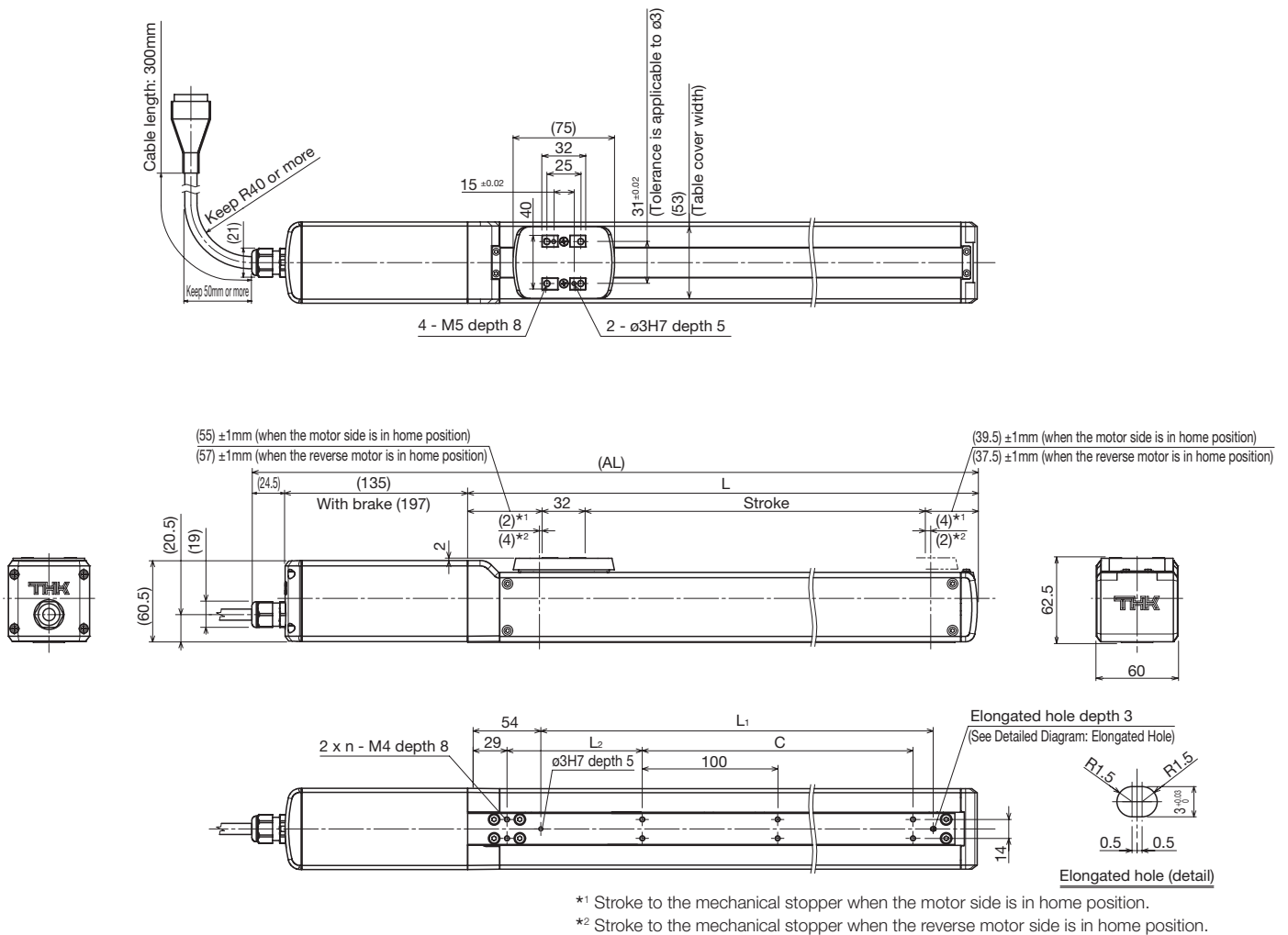

*1 Stroke to the mechanical stopper when the motor side is in home position.
 *2 Stroke to the mechanical stopper when the reverse motor side is in home position.

Stroke [mm] (Stroke between mechanical stoppers)		50 (56)	100 (106)	150 (156)	200 (206)	250 (256)	300 (306)	350 (356)	400 (406)	450 (456)	500 (506)	550 (556)	600 (606)
Maximum speed *1 *2 [mm/s]	Ball screw lead: 6mm	300										270	230
	Ball screw lead: 12mm	500										460	
Dimensions [mm]	AL *3	336 (398)	386 (448)	436 (498)	486 (548)	536 (598)	586 (648)	636 (698)	686 (748)	736 (798)	786 (848)	836 (898)	886 (948)
	L	176.5	226.5	276.5	326.5	376.5	426.5	476.5	526.5	576.5	626.5	676.5	726.5
	L ₁	90	140	190	240	290	340	390	440	490	540	590	640
	L ₂	100	50	100	50	100	50	100	50	100	50	100	50
Mounting hole count	n	2	3	3	4	4	5	5	6	6	7	7	8
Weight *3 [kg]		2.4 (2.9)	2.6 (3)	2.7 (3.2)	2.8 (3.3)	3 (3.5)	3.1 (3.6)	3.3 (3.8)	3.4 (3.9)	3.5 (4)	3.7 (4.2)	3.8 (4.3)	4 (4.5)

*1 Load capacity and maximum speed vary dependent on usage conditions. For details, see "Speed and Load Capacity".
 *2 Dependent on permissible rotational speed of ball screw.
 *3 Values when a brake is installed are shown in parentheses.



ES6R Slider type TSC specification Motor wrap

Model Configuration

Model	Ball screw lead	Stroke	Design symbol	Control device Type	Option	Motor used	Home position	Cable length
ES6R	06	0150	B	TS	MR-GR	42P	D00	S3
ES6R	06: 6mm 12: 12mm	0050: 50mm to 0600: 600mm	B	TS: TSC	MR: Motor right-turn folded ML: Motor left-turn folded GR: Change the cover color to gray SB: With slider base <input type="checkbox"/> 1 <input type="checkbox"/> 2: Sensors	42P: <input type="checkbox"/> 42 42PB: <input type="checkbox"/> 42 with brake	D00: Motor side R00: Reverse motor side	No symbol: None S3: Standard 3m S5: Standard 5m SA*: Standard 10m

* To select SA, insert a noise filter to the TSC power supply. Recommended noise filter is "RSAN-2003 (TDK-Lambda Corporation)".

Basic Specifications

Control device type		TSC	
Motor		<input type="checkbox"/> 42	
Ball screw lead [mm]		6	12
Maximum load	Acceleration and deceleration rate	0.3G	8
	Horizontal mount	0.2G	6
Weight [kg]	Vertical	2	1
	Vertical	0.2G	1
Running life *1 [km]		5000	
Positioning repeatability [mm]		±0.020	
Lost motion [mm]		0.1	
Static permissible moment ** [N·m]		M _A : 10.5, M _B : 22, M _C : 22.1	

*1 Service life is based on below conditions.

Conditions: Horizontal or vertical, under the maximum load capacity, overhang length A=6mm, B and C=0mm, 0.3G for horizontal, 0.2G for vertical, stroke 50mm

*2 Maximum permissible moment when unit is stationary.

Applied point of moment load for MA and MC are the top face of the table, and that for MB is the center of the table.

Static Permissible Moment

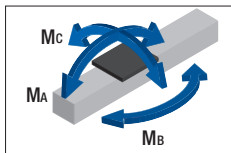

Speed and Load Capacity: Relationship Diagram

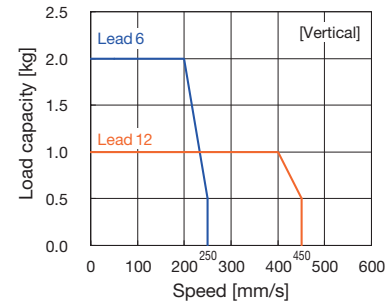
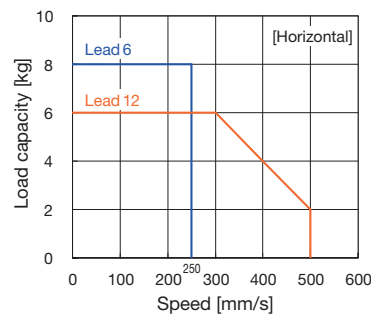

Permissible Overhang Length *

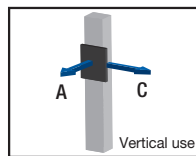
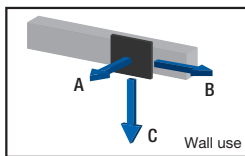
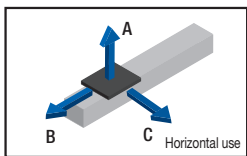

Horizontal mount [mm]				
Ball screw lead [mm]	Load mass [kg]	A	B	C
6	4	500	110	260
	8	340	50	120
12	3	500	160	280
	6	320	70	130

Wall mount [mm]				
Ball screw lead [mm]	Load mass [kg]	A	B	C
6	4	210	90	500
	8	70	30	300
12	3	250	130	500
	6	90	50	240

Vertical mount [mm]			
Ball screw lead [mm]	Load mass [kg]	A	C
6	1	450	450
	2	210	210
12	0.5	500	500
	1	420	420

* Distance from the center of the top face of the table to the load center of gravity position under the following conditions: 5,000km running life, single-direction load, 0.3G horizontal, 0.2G vertical, 150mm stroke.

ES6R + TSC



Dimensions

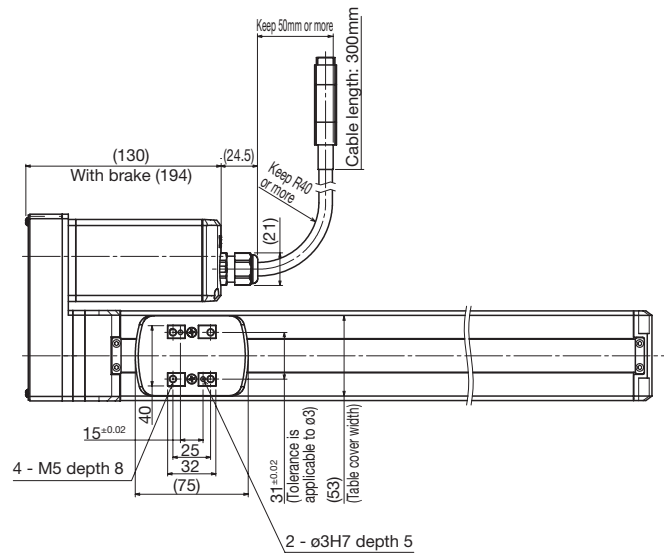

(55) ±1mm (when the motor side is in home position)
 (57) ±1mm (when the reverse motor is in home position)

(39.5) ±1mm (when the motor side is in home position)
 (37.5) ±1mm (when the reverse motor is in home position)

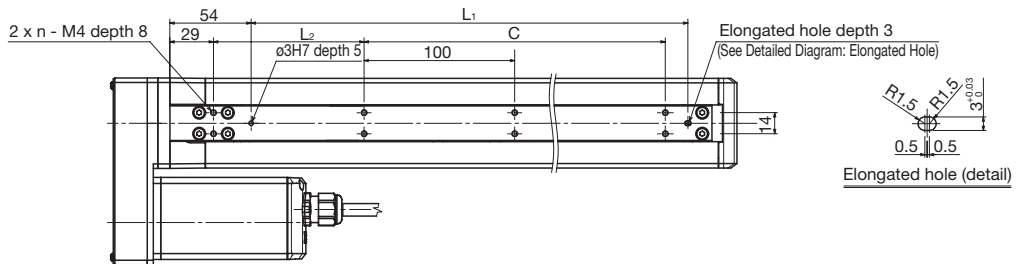
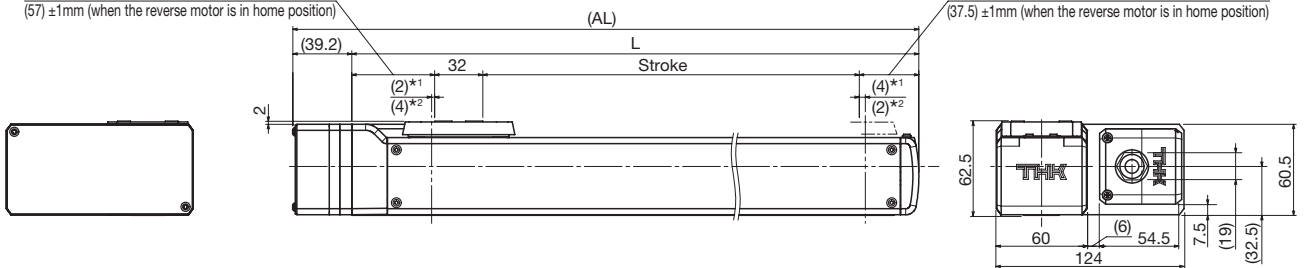

*1 Stroke to the mechanical stopper when the motor side is in home position.

*2 Stroke to the mechanical stopper when the reverse motor side is in home position.

Stroke [mm] (Stroke between mechanical stoppers)		50 (56)	100 (106)	150 (156)	200 (206)	250 (256)	300 (306)	350 (356)	400 (406)	450 (456)	500 (506)	550 (556)	600 (606)
Maximum speed ^{*1} ^{*2} [mm/s]	Ball screw lead: 6mm	250											
	Ball screw lead: 12mm	Horizontal: 500, Vertical: 450											
Dimensions [mm]	AL	215.7	265.7	315.7	365.7	415.7	465.7	515.7	565.7	615.7	665.7	715.7	765.7
	L	176.5	226.5	276.5	326.5	376.5	426.5	476.5	526.5	576.5	626.5	676.5	726.5
	L ₁	90	140	190	240	290	340	390	440	490	540	590	640
	L ₂	100	50	100	50	100	50	100	50	100	50	100	50
	C	0	100	100	200	200	300	300	400	400	500	500	600
Mounting hole count	n	2	3	3	4	4	5	5	6	6	7	7	8
Weight ^{*3} [kg]		2.5 (3.1)	2.7 (3.3)	2.8 (3.4)	2.9 (3.5)	3.1 (3.7)	3.2 (3.8)	3.4 (4)	3.5 (4.1)	3.7 (4.3)	3.8 (4.4)	4 (4.6)	4.1 (4.7)

*1 Load capacity and maximum speed vary dependent on usage conditions. For details, see "Speed and Load Capacity".

*2 Dependent on permissible rotational speed of ball screw.

*3 Values when a brake is installed are shown in parentheses.

*4 Horizontal: 460, Vertical: 450

EC3

Cylinder type TSC specification Direct motor coupling



Model Configuration

Model	Ball screw lead	Stroke	Design symbol	Control device Type	Option	Motor used	Home position	Cable length
EC3	06	0150	B	TS	GR-FL-LB	35P	D00	S3
EC3	06: 6mm	0050: 50mm to 0200: 200mm	B	TS: TSC	No symbol: None GR : Change the cover color to gray CB : With cylinder base FL : With flange LB : With link ball	35P: □35 35PB: □35 with brake	D00: Motor side R00: Reverse motor side	No symbol: None S3 : Standard 3m S5 : Standard 5m SA*: Standard 10m

* To select SA, insert a noise filter to the TSC power supply.
Recommended noise filter is "RSAN-2003 (TDK-Lambda Corporation)".

Basic Specifications

Control device type		TSC	
Motor		□35	
Ball screw lead [mm]		6	12
Maximum load and deceleration rate	Acceleration rate	0.3G	15
	Horizontal mount	0.2G	6
Weight [kg]	Vertical	0.2G	1
	Running life *1 [km]	5000	
Positioning repeatability [mm]		±0.020	
Lost motion [mm]		0.1	
Static permissible moment *2 [N·m]		±1.5	

*1 Service life is based on below conditions.

Conditions: Horizontal or vertical, under the maximum load capacity, overhang length A=6mm, B and C=0mm, 0.3G for horizontal, 0.2G for vertical, stroke 50mm

*2 Maximum permissible moment when unit is stationary.

Applied point of moment load for MA and MC are the top face of the table, and that for MB is the center of the table.

Speed and Load Capacity: Relationship Diagram

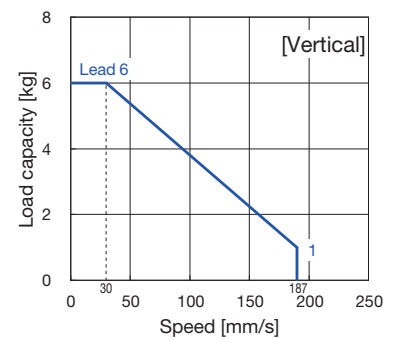
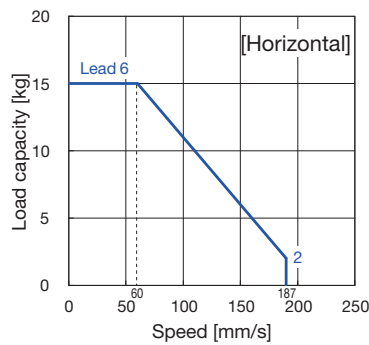

EC3 + TSC



Dimensions

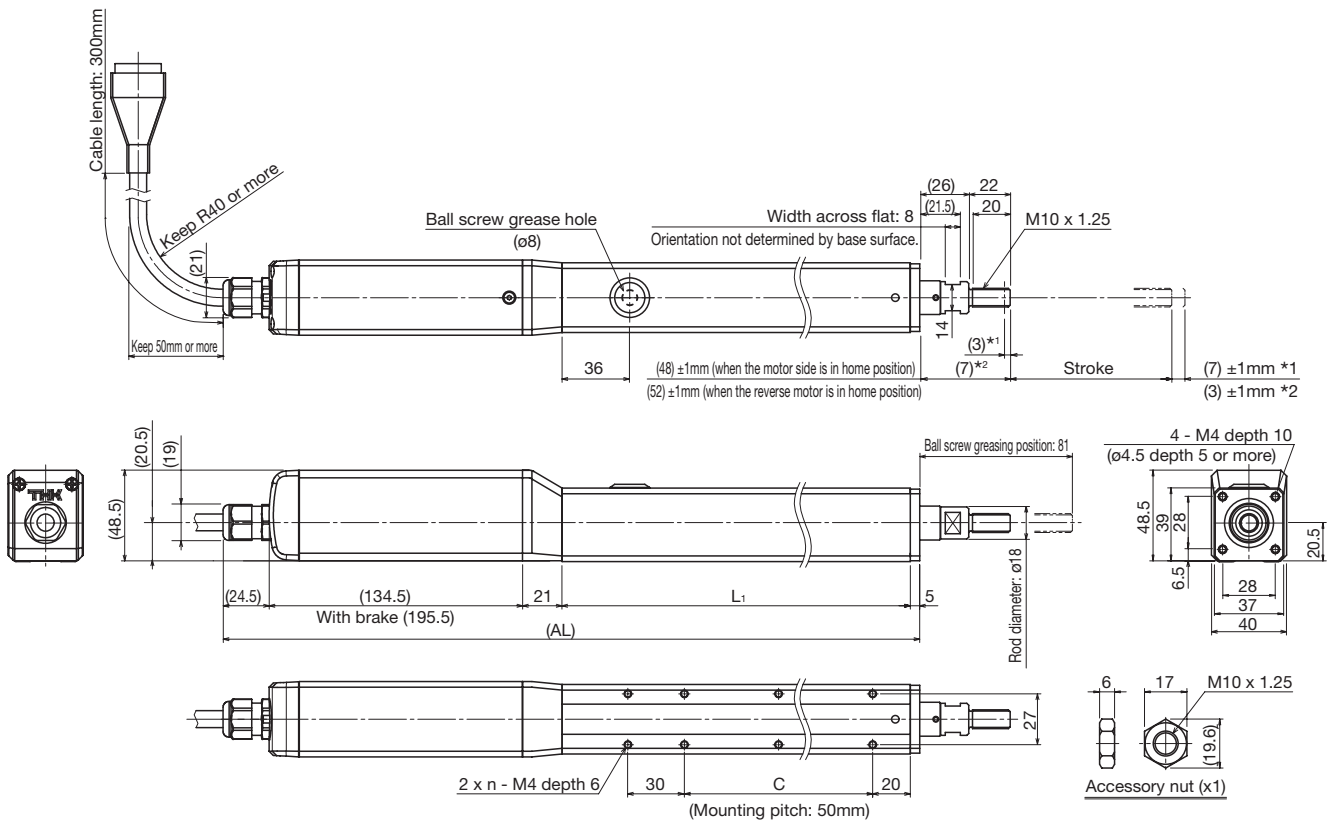

*1 Stroke to the mechanical stopper when the motor side is in home position.

*2 Stroke to the mechanical stopper when the reverse motor side is in home position.

Stroke [mm] (Stroke between mechanical stoppers)		50 (60)	100 (110)	150 (160)	200 (210)
Maximum speed *1 *2 [mm/s]	Ball screw lead: 6mm	187			
Dimensions [mm]	AL *3	320 (381)	370 (431)	420 (481)	470 (531)
	L ₁	135	185	235	285
	C	50	100	150	200
Mounting hole count	n	3	4	5	6
Weight *3 [kg]		1.4 (1.8)	1.6 (2)	1.8 (2.2)	2 (2.4)

*1 Load capacity and maximum speed vary dependent on usage conditions. For details, see "Speed and Load Capacity".

*2 Dependent on permissible rotational speed of ball screw.

*3 Values when a brake is installed are shown in parentheses.

EC3R

Cylinder type TSC specification Motor wrap



Model Configuration

Model	Ball screw lead	Stroke	Design symbol	Control device Type	Option	Motor used	Home position	Cable length
EC3R	06	0150	B	TS	MR-GR-FL-LB	35P	D00	S3
EC3R	06: 6mm	0050: 50mm to 0200: 200mm	B	TS: TSC	MR: Motor right-turn folded ML: Motor left-turn folded GR: Change the cover color to gray CB: With cylinder base FL: With flange LB: With link ball	35P: □35 35PB: □35 with brake	D00: Motor side R00: Reverse motor side	No symbol: None S3: Standard 3m S5: Standard 5m SA*: Standard 10m

* To select SA, insert a noise filter to the TSC power supply.
Recommended noise filter is "RSAN-2003 (TDK-Lambda Corporation)".

Basic Specifications

Control device type		TSC	
Motor		□35	
Ball screw lead [mm]		6	
Maximum load and deceleration rate	Horizontal mount	0.3G	15
	Vertical	0.2G	3
Weight *1 [kg]			
Running life *2 [km]		5000	
Positioning repeatability [mm]		±0.020	
Lost motion [mm]		0.1	
Rod non-rotational accuracy [°]		±1.5	

*1 Only axial loads permissible.

Only an axial load may be applied to rod via LM Guide. LM Guide sliding resistance must be considered when making selection.

*2 The following conditions apply to running life.

Conditions: Under the maximum load capacity (with LM guide), maximum speed, 0.3G for horizontal, 0.2G for vertical

Speed and Load Capacity: Relationship Diagram

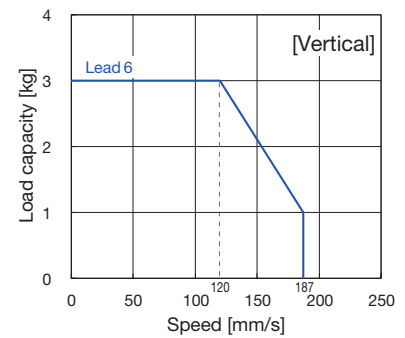
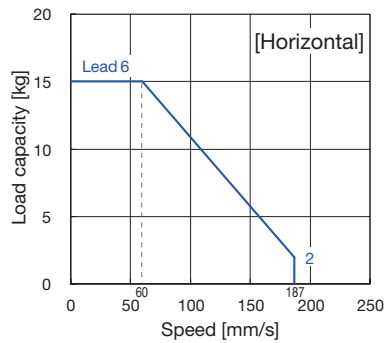

EC3R + TSC



Dimensions

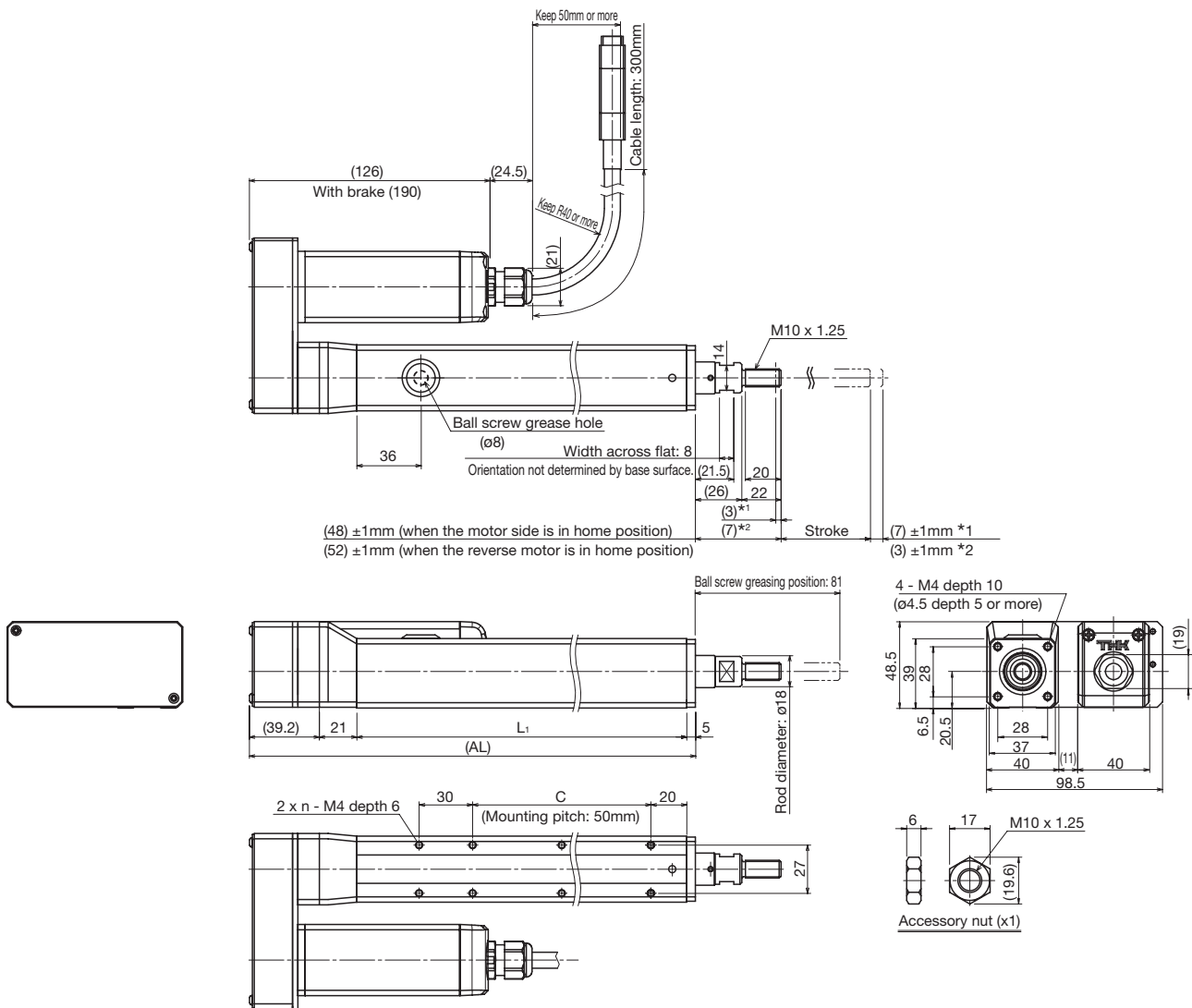

*1 Stroke to the mechanical stopper when the motor side is in home position.

*2 Stroke to the mechanical stopper when the reverse motor side is in home position.

Stroke [mm] (Stroke between mechanical stoppers)		50 (60)	100 (110)	150 (160)	200 (210)
Maximum speed *1*2 [mm/s]	Ball screw lead: 6mm	187			
Dimensions [mm]	AL	200.2	250.2	300.2	350.2
	L ₁	135	185	235	285
	C	50	100	150	200
Mounting hole count	n	3	4	5	6
Weight *3 [kg]		1.4 (1.8)	1.6 (2.0)	1.8 (2.2)	2 (2.4)

*1 Load capacity and maximum speed vary dependent on usage conditions. For details, see "Speed and Load Capacity".

*2 Dependent on permissible rotational speed of ball screw.

*3 Values when a brake is installed are shown in parentheses.

EC3H

Cylinder type TSC specification Direct motor coupling/with linear bush



Model Configuration

Model	Ball screw lead	Stroke	Design symbol	Control device Type	Option	Motor used	Home position	Cable length
EC3H	06	0150	B	TS	GR-CB	35P	D00	S3
EC3H	06: 6mm	0050: 50mm to 0200: 200mm	B	TS: TSC	No symbol: None GR: Change the cover color to gray CB: With cylinder base	35P: □35 35PB: □35 with brake	D00: Motor side R00: Reverse motor side	No symbol: None S3 : Standard 3m S5 : Standard 5m SA*: Standard 10m

* To select SA, insert a noise filter to the TSC power supply.
Recommended noise filter is *RSAN-2003 (TDK-Lambda Corporation).

Basic Specifications

Control device type		TSC	
Motor		□35	
Ball screw lead [mm]		6	
Maximum load Weight *1*2 [kg]	Acceleration and deceleration rate	Horizontal mount	0.3G
		Vertical	0.2G
Running life *2*3 [km]		5000	
Positioning repeatability [mm]		±0.020	
Lost motion [mm]		0.1	
Rod non-rotational accuracy [°]		±0.05	

*1 Only axial loads permissible.

Only an axial load may be applied to rod via LM Guide. LM Guide sliding resistance must be considered when making selection.

*2 Load capacity and running life may vary without an LM guide. For details, see "Reference End Load and Running Life".

*3 The following conditions apply to running life.

Conditions: Under the maximum load capacity (with LM guide), maximum speed, 0.3G for horizontal, 0.2G for vertical

Speed and Load Capacity: Relationship Diagram

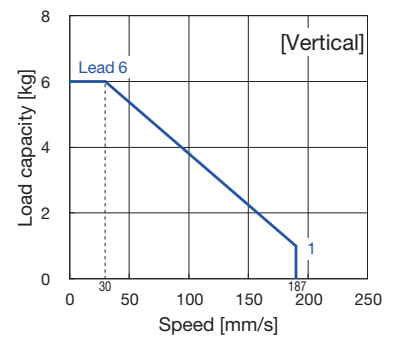
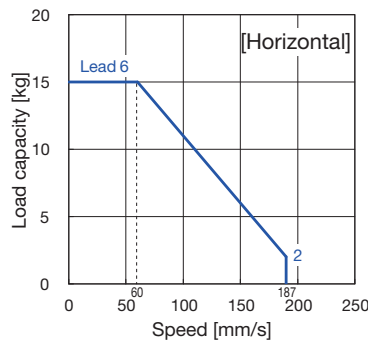

Reference End Load and Running Life

Running life varies when a load is applied to the end of the unit without using an LM Guide, as shown below.

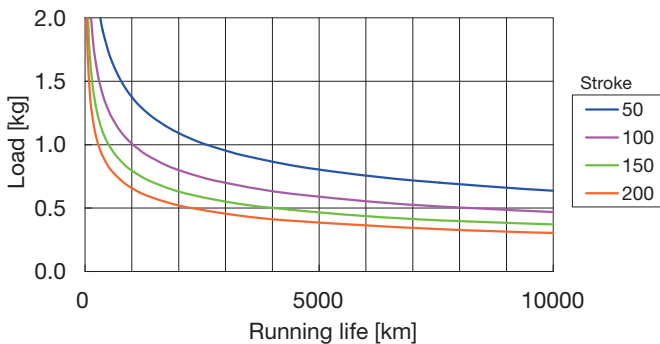

EC3H + TSC



Dimensions

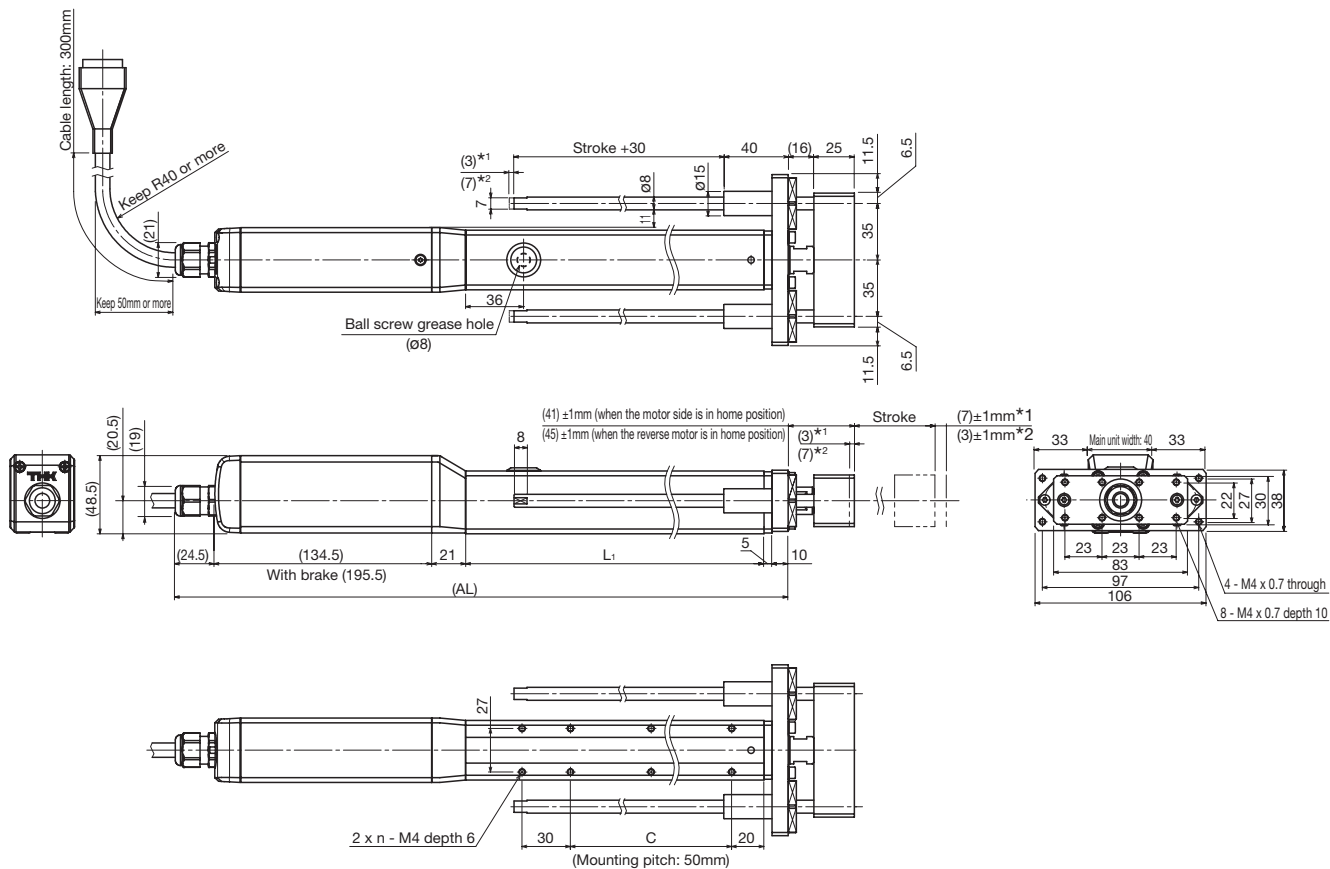

*1 Stroke to the mechanical stopper when the motor side is in home position.

*2 Stroke to the mechanical stopper when the reverse motor side is in home position.

Stroke [mm] (Stroke between mechanical stoppers)		50 (60)	100 (110)	150 (160)	200 (210)
Maximum speed *1*2 [mm/s]	Ball screw lead: 6mm	187			
Dimensions [mm]	AL*3	330 (391)	380 (441)	430 (491)	480 (541)
	L ₁	135	185	235	285
	C	50	100	150	200
Mounting hole count	n	3	4	5	6
Weight *3 [kg]		1.7 (2.1)	1.9 (2.4)	2.2 (2.6)	2.4 (2.9)

*1 Load capacity and maximum speed vary dependent on usage conditions. For details, see "Speed and Load Capacity".

*2 Dependent on permissible rotational speed of ball screw.

*3 Values when a brake is installed are shown in parentheses.

EC4 Cylinder type TSC specification Direct motor coupling

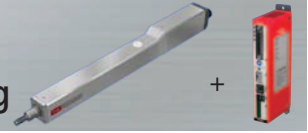

Model Configuration

Model	Ball screw lead	Stroke	Design symbol	Control device Type	Option	Motor used	Home position	Cable length
EC4	06	0150	B	TS	GR-FL-LB	42P	D00	S3
EC4	06: 6mm 12: 12mm	0050: 50mm to 0300: 300mm	B	TS: TSC	No symbol: None GR : Change the cover color to gray CB : With cylinder base FL : With flange LB : With link ball	42P: □42 42PB: □42 with brake	D00: Motor side R00: Reverse motor side	No symbol: None S3 : Standard 3m S5 : Standard 5m SA*: Standard 10m

* To select SA, insert a noise filter to the TSC power supply.
Recommended noise filter is "RSAN-2003 (TDK-Lambda Corporation)".

Basic Specifications

Control device type		TSC	
Motor		□42	
Ball screw lead [mm]		6	12
Maximum load Weight *1 [kg]	Acceleration and deceleration rate	Horizontal mount	0.3G
	Vertical	0.2G	40
Running life *2 [km]		5000	
Positioning repeatability [mm]		±0.020	
Lost motion [mm]		0.1	
Rod non-rotational accuracy [°]		±1.5	

*1 Only axial loads permissible.

Only an axial load may be applied to rod via LM Guide. LM Guide sliding resistance must be considered when making selection.

*2 The following conditions apply to running life.

Conditions: Under the maximum load capacity (with LM guide), maximum speed, 0.3G for horizontal, 0.2G for vertical

Speed and Load Capacity: Relationship Diagram

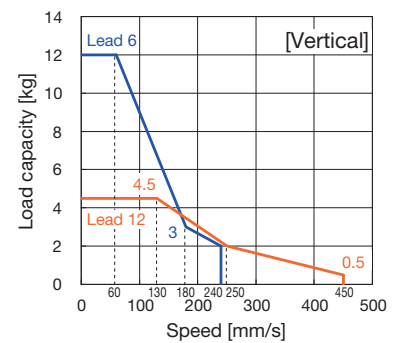
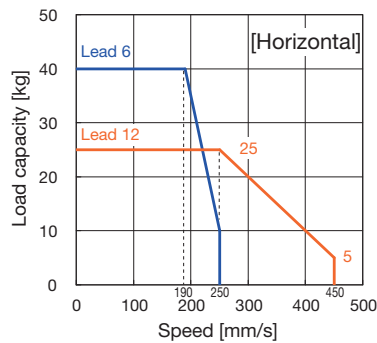

EC4 + TSC



Dimensions

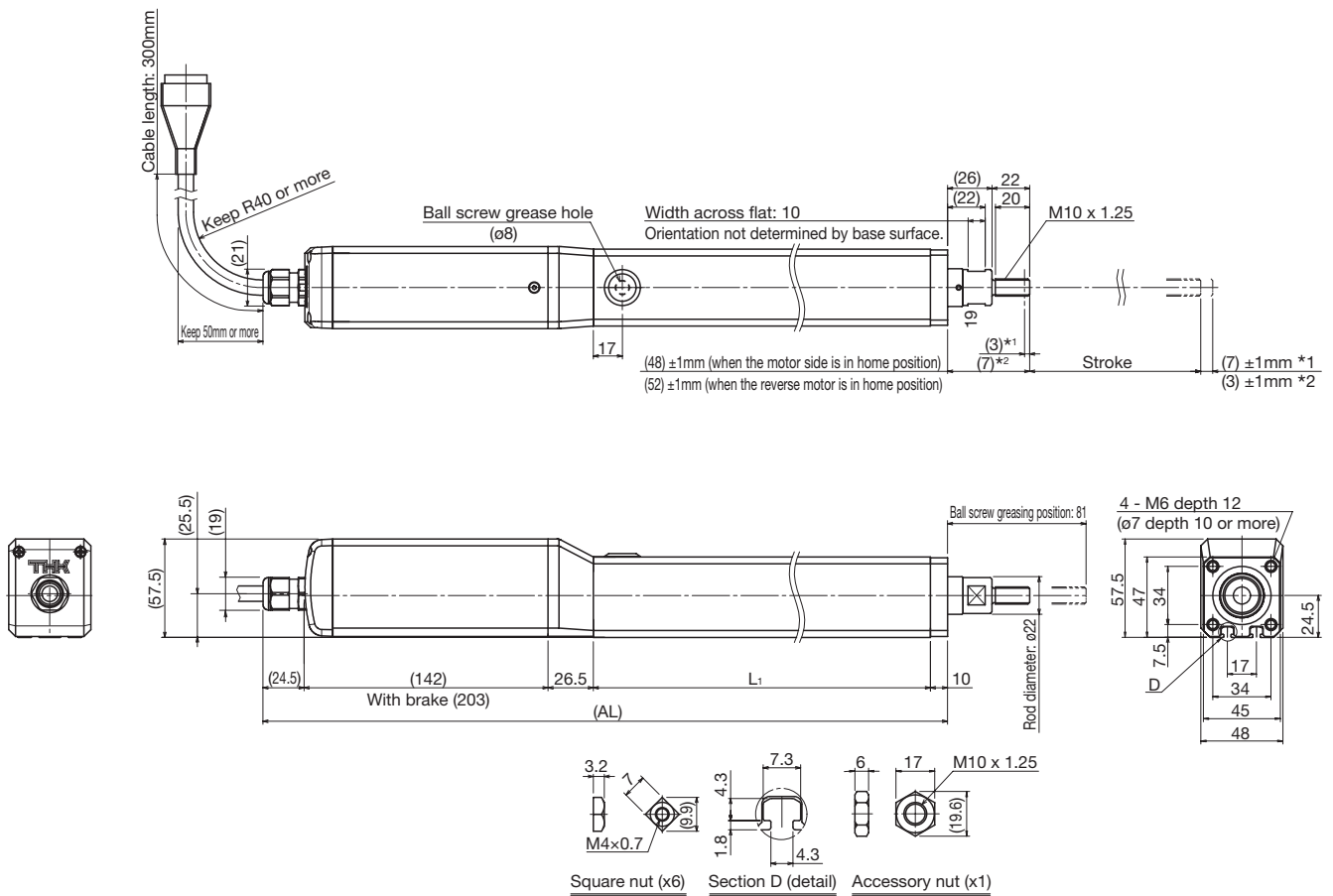

*1 Stroke to the mechanical stopper when the motor side is in home position.

*2 Stroke to the mechanical stopper when the reverse motor side is in home position.

Stroke [mm] (Stroke between mechanical stoppers)		50 (60)	100 (110)	150 (160)	200 (210)	250 (260)	300 (310)
Maximum speed ^{*1} ^{*2} [mm/s]	Ball screw lead: 6mm	Horizontal: 250, Vertical: 240				230	170
	Ball screw lead: 12mm	450					340
Dimensions [mm]	AL ^{*3}	350 (411)	400 (461)	450 (511)	500 (561)	550 (611)	600 (661)
	L ₁ ^{*4}	147	197	247	297	347	397
Weight ^{*3} [kg]		2.3 (2.9)	2.6 (3.2)	3 (3.5)	3.3 (3.8)	3.6 (4.2)	4 (4.5)

*1 Load capacity and maximum speed vary dependent on usage conditions. For details, see "Speed and Load Capacity".

*2 Dependent on permissible rotational speed of ball screw.

*3 Values when a brake is installed are shown in parentheses.

*4 The dimension of the T slot corresponds to L₁.

EC4R

Cylinder type TSC specification Motor wrap

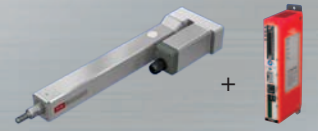

Model Configuration

Model	Ball screw lead	Stroke	Design symbol	Control device Type	Option	Motor used	Home position	Cable length
EC4R	06	0150	B	TS	MR-GR-FL-LB	42P	D00	S3
EC4R	06: 6mm 12: 12mm	0050: 50mm to 0300: 300mm	B	TS: TSC	MR: Motor right-turn folded ML: Motor left-turn folded GR: Change the cover color to gray CB: With cylinder base FL: With flange LB: With link ball	42P: □42 42PB: □42 with brake	D00: Motor side R00: Reverse motor side	No symbol: None S3 : Standard 3m S5 : Standard 5m SA*: Standard 10m

* To select SA, insert a noise filter to the TSC power supply.
Recommended noise filter is "RSAN-2003 (TDK-Lambda Corporation)".

Basic Specifications

Control device type		TSC	
Motor		□42	
Ball screw lead [mm]		6	12
Maximum load Weight *1 [kg]	Acceleration and deceleration rate	Horizontal mount	0.3G
	Vertical	0.2G	6
Running life *2 [km]		5000	
Positioning repeatability [mm]		±0.020	
Lost motion [mm]		0.1	
Rod non-rotational accuracy [°]		±1.5	

*1 Only axial loads permissible.

Only an axial load may be applied to rod via LM Guide. LM Guide sliding resistance must be considered when making selection.

*2 The following conditions apply to running life.

Conditions: Under the maximum load capacity (with LM guide), maximum speed, 0.3G for horizontal, 0.2G for vertical

Speed and Load Capacity: Relationship Diagram

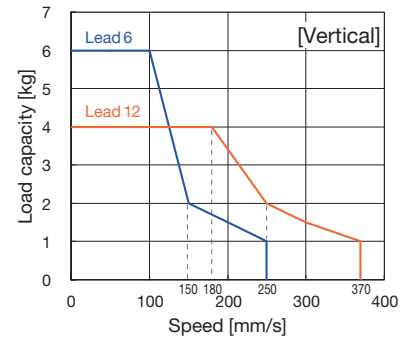
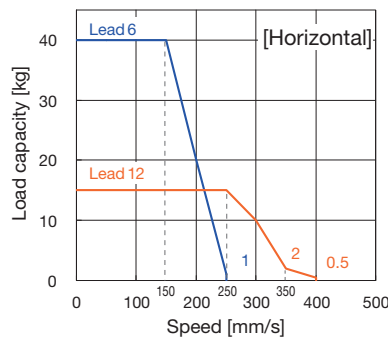

EC4R + TSC



Dimensions

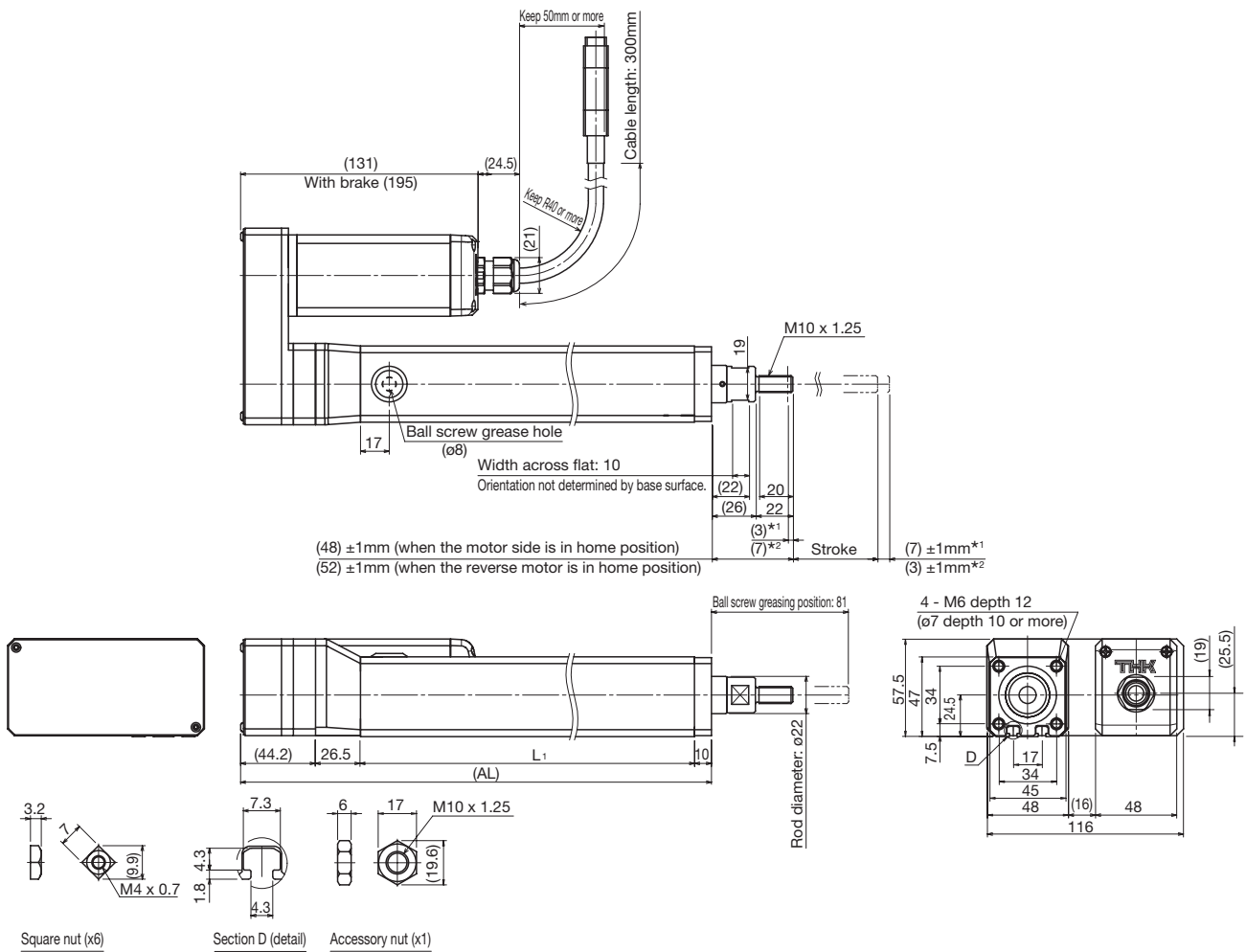

*¹ Stroke to the mechanical stopper when the motor side is in home position.

*² Stroke to the mechanical stopper when the reverse motor side is in home position.

Stroke [mm] (Stroke between mechanical stoppers)		50 (60)	100 (110)	150 (160)	200 (210)	250 (260)	300 (310)
Maximum speed * ¹ * ² [mm/s]	Ball screw lead: 6mm	250				230	170
	Ball screw lead: 12mm	Horizontal: 400, Vertical: 370					340
Dimensions [mm]	AL	227.7	277.7	327.7	377.7	427.7	477.7
	L ³	147	197	247	297	347	397
Weight * ⁴ [kg]		2.3 (2.9)	2.6 (3.2)	2.9 (3.6)	3.3 (3.9)	3.6 (4.2)	3.9 (4.5)

*¹ Load capacity and maximum speed vary dependent on usage conditions. For details, see "Speed and Load Capacity".

*² Dependent on permissible rotational speed of ball screw.

*³ The dimension of the T slot corresponds to L¹.

*⁴ Values when a brake is installed are shown in parentheses.

EC4H

Cylinder type TSC specification Direct motor coupling/with linear bush



Model Configuration

Model	Ball screw lead	Stroke	Design symbol	Control device Type	Option	Motor used	Home position	Cable length
EC4H	06	0150	B	TS	GR-CB	42P	D00	S3
EC4H	06: 6mm 12: 12mm	0050: 50mm to 0300: 300mm	B	TS: TSC	No symbol: None GR: Change the cover color to gray CB: With cylinder base	42P: □42 42PB: □42 with brake	D00: Motor side R00: Reverse motor side	No symbol: None S3: Standard 3m S5: Standard 5m SA*: Standard 10m

* To select SA, insert a noise filter to the TSC power supply. Recommended noise filter is "RSAN-2003 (TDK-Lambda Corporation)".

Basic Specifications

Control device type		TSC	
Motor		□42	
Ball screw lead [mm]		6	12
Maximum load Weight *1*2 [kg]	Acceleration and deceleration rate	Horizontal mount	0.3G
		Vertical	0.2G
Running life *2*3 [km]		5000	
Positioning repeatability [mm]		±0.020	
Lost motion [mm]		0.1	
Rod non-rotational accuracy [°]		±0.05	

*1 Only axial loads permissible.

Only an axial load may be applied to rod via LM Guide. LM Guide sliding resistance must be considered when making selection.

*2 Load capacity and running life may vary without an LM guide. For details, see "Reference End Load and Running Life".

*3 The following conditions apply to running life.

Conditions: Under the maximum load capacity (with LM guide), maximum speed, 0.3G for horizontal, 0.2G for vertical

Speed and Load Capacity: Relationship Diagram

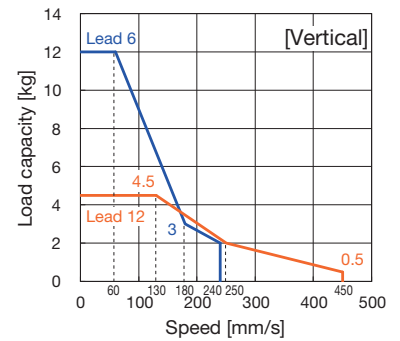
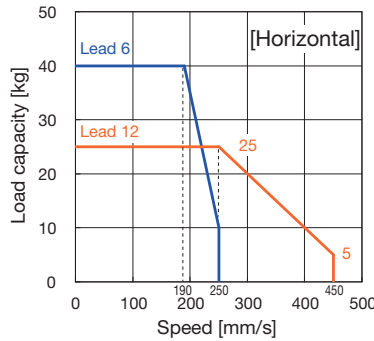

Reference End Load and Running Life

Running life varies when a load is applied to the end of the unit without using an LM Guide, as shown below.

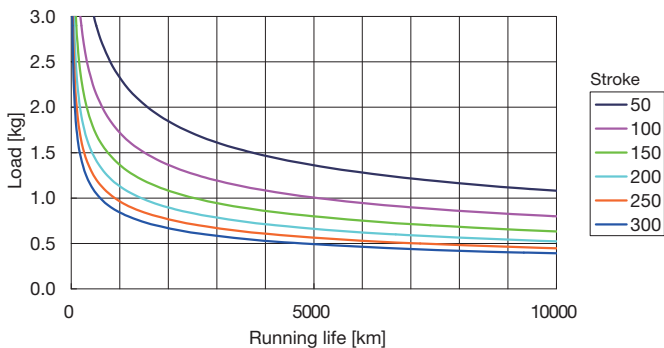

EC4H + TSC



Dimensions

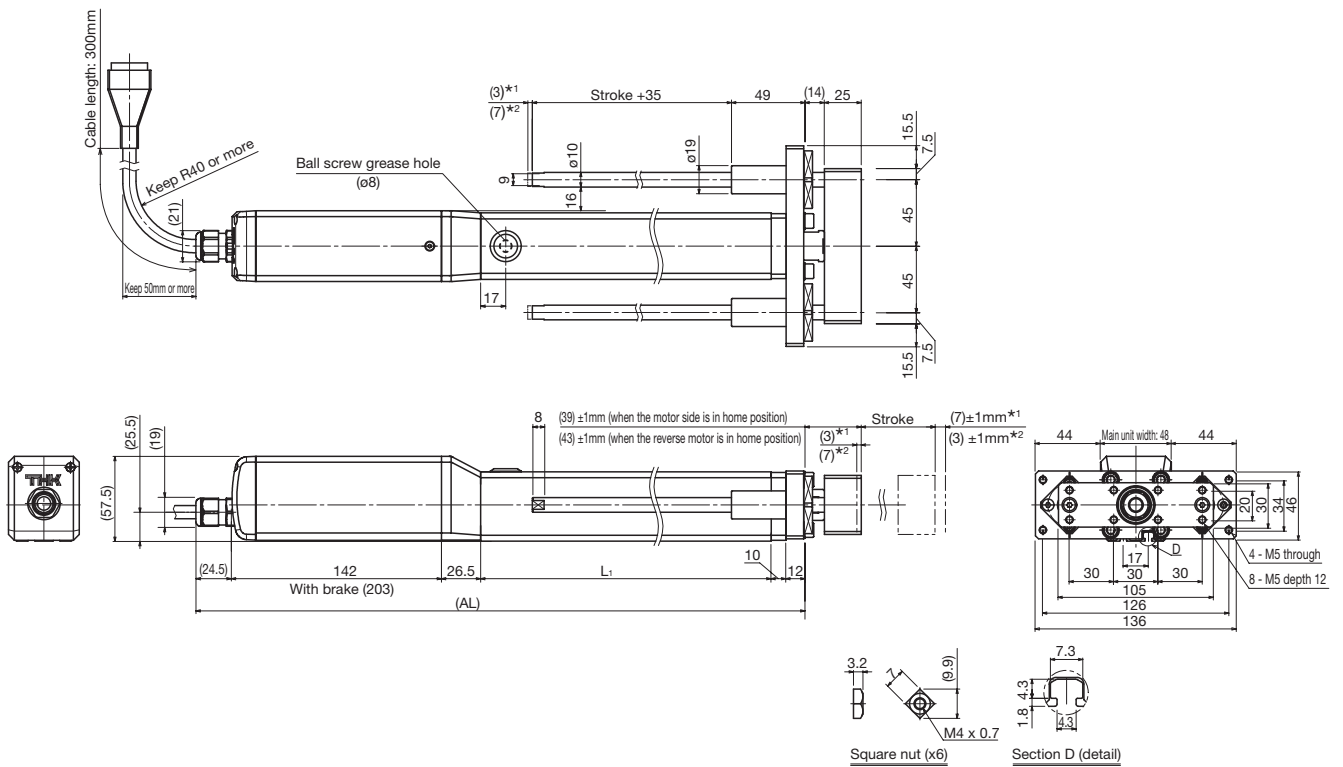

*1 Stroke to the mechanical stopper when the motor side is in home position.

*2 Stroke to the mechanical stopper when the reverse motor side is in home position.

Stroke [mm] (Stroke between mechanical stoppers)		50 (60)	100 (110)	150 (160)	200 (210)	250 (260)	300 (310)
Maximum speed ^{*1 *2} [mm/s]	Ball screw lead: 6mm	Horizontal: 250, Vertical: 240				230	170
	Ball screw lead: 12mm	450				340	340
Dimensions [mm]	AL ^{*3}	362 (423)	412 (473)	462 (523)	512 (573)	562 (623)	612 (673)
	L ₁ ^{*4}	147	197	247	297	347	397
Weight ^{*3} [kg]		2.8 (3.4)	3.1 (3.8)	3.5 (4.1)	3.9 (4.5)	4.2 (4.8)	4.6 (5.2)

*1 Load capacity and maximum speed vary dependent on usage conditions. For details, see "Speed and Load Capacity".

*2 Dependent on permissible rotational speed of ball screw.

*3 Values when a brake is installed are shown in parentheses.

*4 The dimension of the T slot corresponds to L₁.

Common options for ES

GR: Change the cover color to gray

As an option for ES, the cover color can be changed from red to gray.

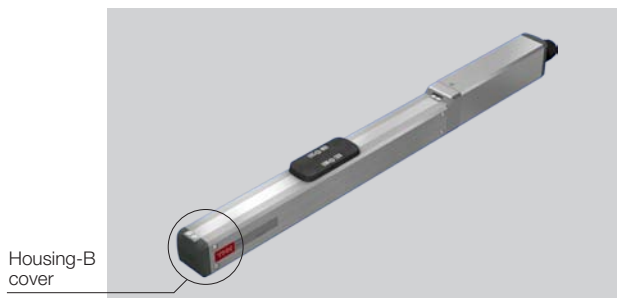

No symbol: red cover



When GR is selected: gray cover

If the GR is not included in the model configuration, cover will be red.

ES Option

SB: Slider base (direct coupled specification)

THK provides a slider base for installing the ES main unit from the top face.
(Included with unit)

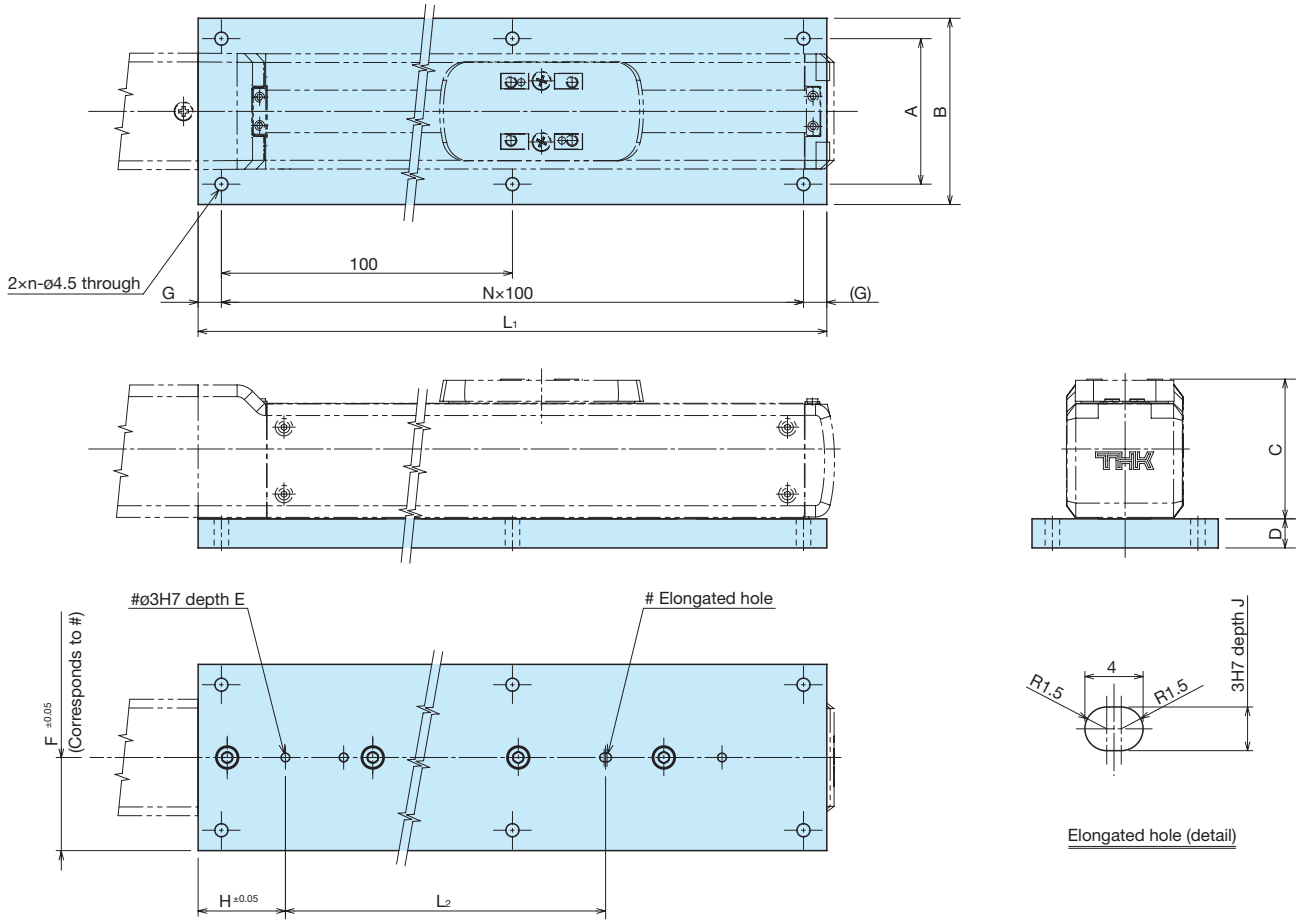

Model	A	B	C	D	E	F	H	J
ES3	42	56	40	8	8	28	40	8
ES4	50	64	48	10	10	32	30	10
ES5	70	84	57	10	10	42	45	10
ES6	70	84	62.5	10	10	42	45	10

Stroke	50	100	150	200	250	300	350	400	450	500	550	600
ES3	L ₁ [mm]	156	206	256	306	356	406	-	-	-	-	-
	L ₂ [mm]	70	120	170	220	270	320	-	-	-	-	-
	n	2	2	3	3	4	4	-	-	-	-	-
	N	1	1	2	2	3	3	-	-	-	-	-
ES4	G [mm]	28	53	28	53	28	53	-	-	-	-	-
	L ₁ [mm]	166	216	266	316	366	416	466	516	-	-	-
	L ₂ [mm]	60	110	160	210	260	310	360	410	-	-	-
	n	2	3	3	4	4	5	5	6	-	-	-
ES5	N	1	2	2	3	3	4	4	5	-	-	-
	G [mm]	37	12	37	12	37	12	37	12	37	12	-
	L ₁ [mm]	174	224	274	324	374	424	474	524	574	624	-
	L ₂ [mm]	70	120	170	220	270	320	370	420	470	520	-
ES6	n	2	3	3	4	4	5	5	6	6	7	-
	N	1	2	2	3	3	4	4	5	5	6	-
	L ₁ [mm]	174	224	274	324	374	424	474	524	574	624	674
	L ₂ [mm]	70	120	170	220	270	320	370	420	470	520	570
G [mm]	37	12	37	12	37	12	37	12	37	12	37	

ES Option

SB: Slider base (motor wrap configuration)

THK provides a slider base for installing the ES main unit from the top face.
(Included with unit)

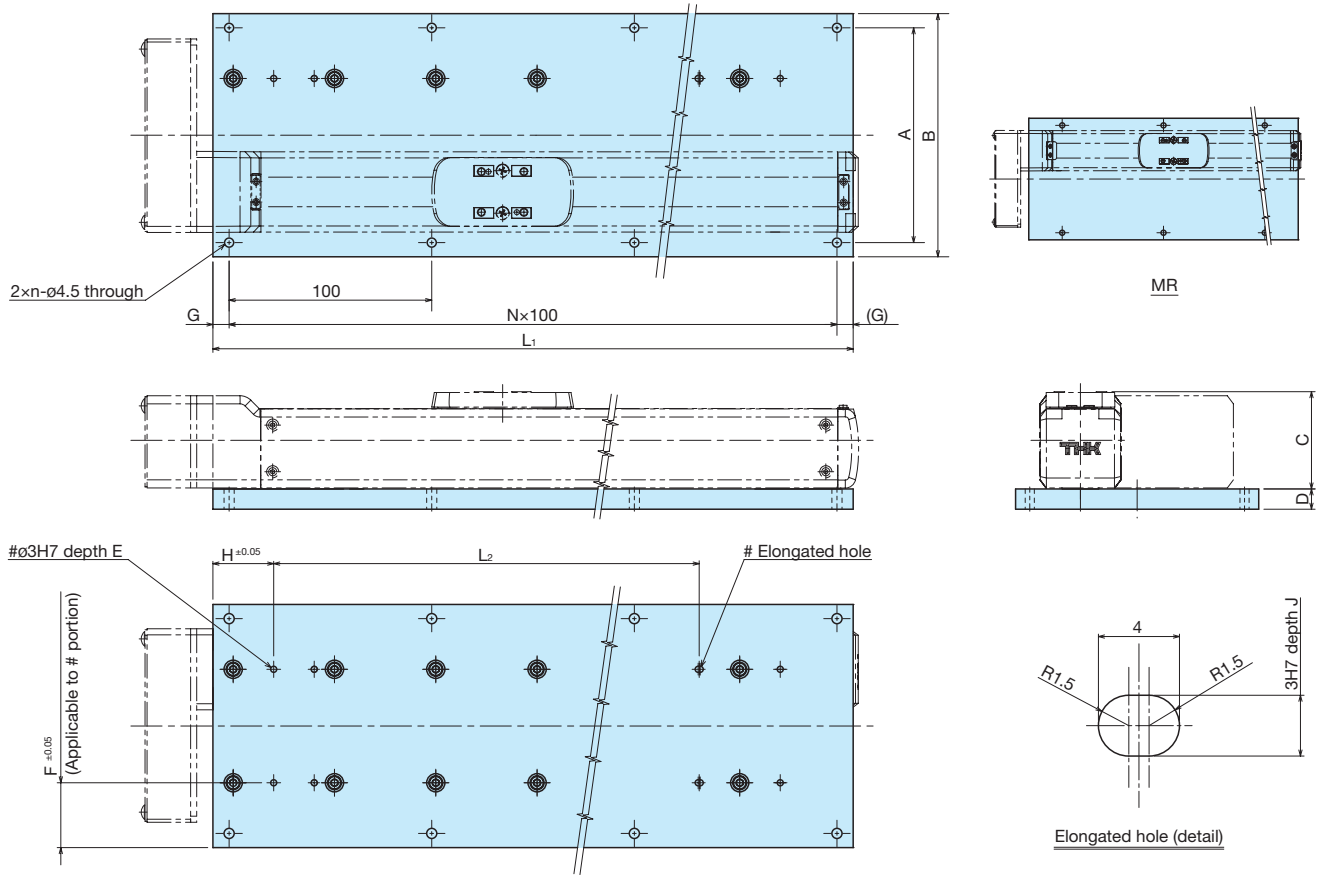

Unit: mm

Model	A	B	C	D	E	F		H	J
						MR	ML		
ES3	92	106	40	8	8	28	78	40	8
ES4	106	120	48	10	10	32	88	30	10
ES5	136	150	57	10	10	42	108	45	10
ES6	136	150	62.5	10	10	42	108	45	10

Stroke	50	100	150	200	250	300	350	400	450	500	550	600
ES3	L ₁ [mm]	156	206	256	306	356	406	-	-	-	-	-
	L ₂ [mm]	70	120	170	220	270	320	-	-	-	-	-
	n	2	2	3	3	4	4	-	-	-	-	-
	N	1	1	2	2	3	3	-	-	-	-	-
	G [mm]	28	53	28	53	28	53	-	-	-	-	-
ES4	L ₁ [mm]	166	216	266	316	366	416	466	516	-	-	-
	L ₂ [mm]	60	110	160	210	260	310	360	410	-	-	-
	n	2	3	3	4	4	5	5	6	-	-	-
	N	1	2	2	3	3	4	4	5	-	-	-
	G [mm]	33	8	33	8	33	8	33	8	-	-	-
ES5	L ₁ [mm]	174	224	274	324	374	424	474	524	574	624	-
	L ₂ [mm]	70	120	170	220	270	320	370	420	470	520	-
	n	2	3	3	4	4	5	5	6	6	7	-
	N	1	2	2	3	3	4	4	5	5	6	-
	G [mm]	37	12	37	12	37	12	37	12	37	12	-
ES6	L ₁ [mm]	174	224	274	324	374	424	474	524	574	624	674
	L ₂ [mm]	70	120	170	220	270	320	370	420	470	520	570
	n	2	3	3	4	4	5	5	6	6	7	8
	N	1	2	2	3	3	4	4	5	5	6	7
	G [mm]	37	12	37	12	37	12	37	12	37	12	37

□₁□₂: Sensors

ES units can be equipped with optional proximity sensors and photo sensors. Sensor-equipped models also feature a dedicated sensor rail. The following precautions apply to sensor-equipped ES units.

1. The customer should provide a sensor target; a sensor target cannot be installed onto the actuator main unit.
2. When ordered, the sensor is included with the unit.
3. When motor wrap is selected, a sensor cannot be mounted on the same side as the folded direction of the motor.
4. When an optional sensor is used, the home position may differ from that indicated in this brochure.
5. When proximity sensors are placed too close to each other, they may not work properly. For closely grouped proximity sensors, the customer must provide sensors with variant frequencies (consult the respective manufacturer for sensor specifications).

Description	Type	Accessory	Symbol	
			□ ₁	□ ₂
With sensor rail	–	–	L/R	1
Photo Sensor * [3 units]	EE-SX674 (OMRON Corporation)	Mounting screw, nuts, sensor rail (x1), mounting plates (x3), connectors (EE-1001, x3)	L/R	6
Sensor N.O. contact [x1] N.C. contact points [x2]	GX-F12A (Panasonic Industrial Devices SUNX Co., Ltd.) GX-F12B (Panasonic Industrial Devices SUNX Co., Ltd.)	Mounting screws, nuts, sensor rail	L/R	J
Sensor N.O. contact [x1] (PNP output) N.C. contact points [x2] (PNP output)	GX-F12A-P (Panasonic Industrial Devices SUNX Co., Ltd.) GX-F12B-P (Panasonic Industrial Devices SUNX Co., Ltd.)	Mounting screws, nuts, sensor rail	L/R	M

N.O. contact: Normally open contact point

N.C. contact: Normally closed contact point

* The photo sensors can be switched between ON when lit and ON when unlit.

Example: When a photo sensor is selected with motor wrap

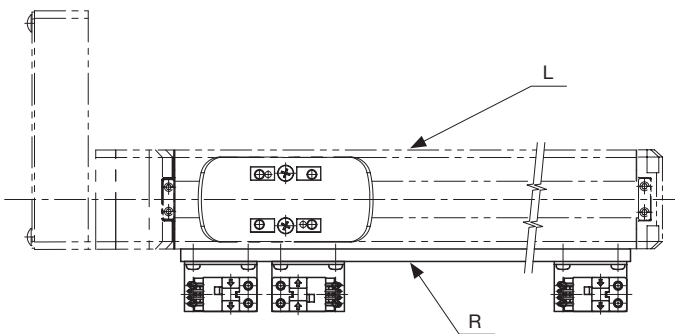

Sensor symbols

Symbol	
□ ₁	□ ₂
R	6

□₁ represents the mounting position for sensor rail and sensor.

□₂ represents the type of sensors.

□₁ on the same side as the folded direction of the motor cannot be selected.

L cannot be selected.

□₁□₂: Sensors

Symbol 1: Sensor rail

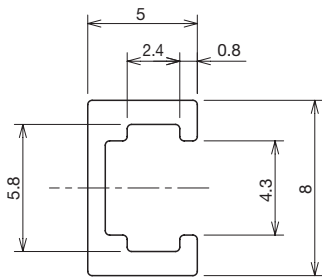
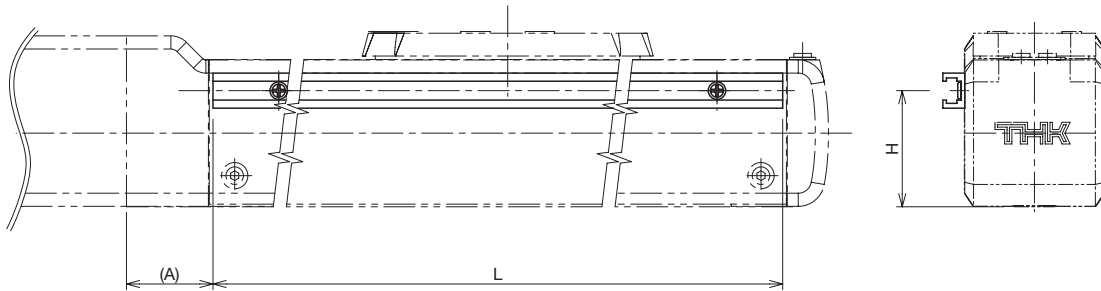

Sensor rail (detail)

Unit: mm

Model	H	A	L
ES3	26.5	19.8	Stroke +78
ES4	31.5	26.5	
ES5	38.1	27	
ES6	43.6	30	

Symbols J, M: Proximity sensor GX-F12* (Panasonic Industrial Devices SUNX Co., Ltd.)

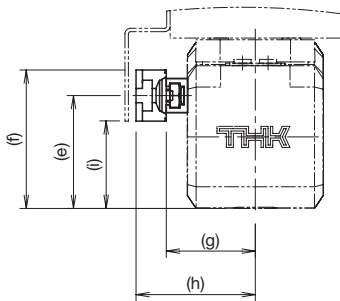

Unit: mm

Model	e	f	g	h	i
ES3	26.5	32.5	20.9	28	20.5
ES4	31.5	37.5	24.8	31.9	25.5
ES5	38.1	44.1	29.8	36.9	32.1
ES6	43.6	49.6	34.8	41.9	37.6

Symbol 6: Photo sensor EE-SX674 (OMRON Corporation)

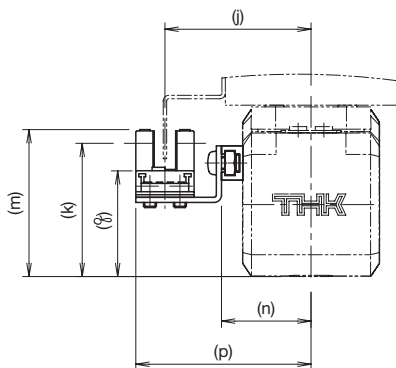

Unit: mm

Model	j	k	m	n	p	φ
ES3	31.4	28.6	31.8	20.9	38.4	22.2
ES4	35.3	33.6	36.8	24.8	42.3	27.2
ES5	40.3	40.2	43.4	29.8	47.3	33.8
ES6	45.3	45.7	48.9	34.8	52.3	39.3

EC Option

CB: Cylinder Base

EC3

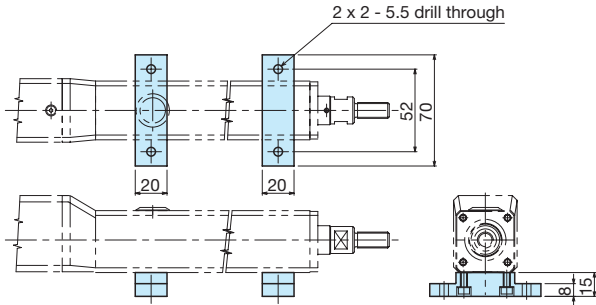

(Included with unit)

EC4

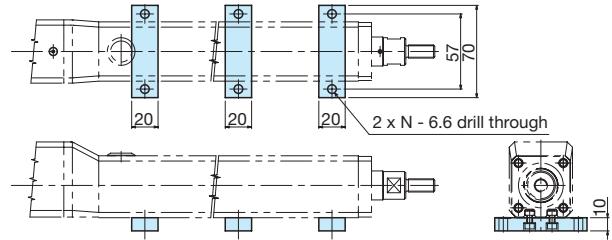

Stroke	50	100	150	200	250	300
N	2	2	2	2	3	3

(Included with unit)

FL: Flange

EC3/4, EC3R/4R

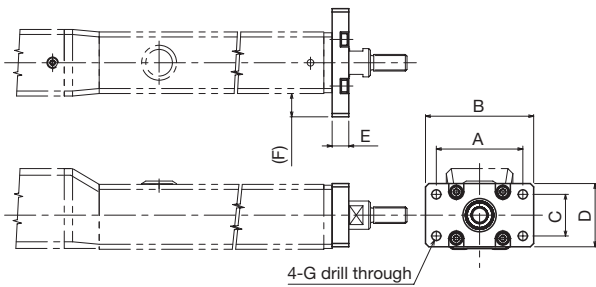

Unit: mm

Model	A	B	C	D	E	F	G
EC3/EC3R	52	65	25	38	10	14	5.5
EC4/EC4R	60	75	34	46	12	15	6.6

(Included with unit)

EC3R (When ST=50)

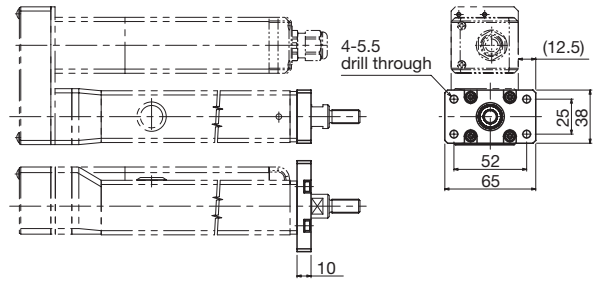

(Included with unit)

LB: Link Ball

EC3/4

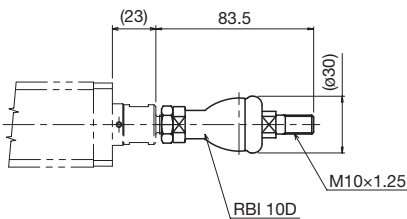

(Included with unit)

Stepper Driver Controller

TSC

For single shaft/Position type



Features

Ready to use by simplified setup.

Simple Operation

Use PC setup tool D-STEP or digital operator TDO to access many useful functions.

Functions

- Selectable function modes
(64-position, external unit input instruction, 256-position, 512-position, Solenoid mode 1, and Solenoid mode 2)
- Step data count: Up to 512 (depending on function mode)
- Alarm history: Up to 50 (including power ON history)
- Switching between Auto/Manual, brake release switch
- Selectable control methods (positioning or pressing)

Changes on the new version (design symbol B) **UPDATE**

TSC is now updated to a new version that specified with “B” in design symbol.

Differences from conventional version, design symbol “A” are shown below.

- Behavior at Servo-On

	Design symbol A	Design symbol B
Motion	Moves several millimeters	Standstill

- Compatibility

Driver controller TSC, and actuator cable does not have compatibility between A and B.

* To use a 10m actuator cable, insert a noise filter to the TSC power supply.

Model Configuration

● Stepper driver controller *Separate order required.

Model	Current	Design symbol	Type	Combined Actuator	Combined actuator ball screw lead	Home position	Brake
TSC	015	B	MOD	ES6	06	D	B
(1)	(2)	(3)	(4)	(5)	(6)	(7)	(8)
TSC	015: 1.5A	B	MOD: Mode switching type	ES3	06: 6mm	D: Motor side	No symbol: Without brake
				ES4	12: 12mm	R: Reverse motor side	B: With brake
				ES5			
				ES6			
				ES3R			
				ES4R			
				ES5R			
				ES6R			
				EC3*1			
				EC4*1			
				EC3R			
				EC4R			

*1 Select "EC3" for EC3H and "EC4" for EC4H.

Basic Specifications

Basic Specifications	Input power supply	24V DC ±10% (Up to 2.5A)					
Control	Control axis	Single shaft					
	Motor type	Stepper motor (□28mm, □35mm, □42mm)					
	Control method	Feedback control (Semi-closed loop)					
	Position detection method	Incremental					
	Acceleration/deceleration method	Trapezoid acceleration					
Program	Function mode	64-position	External unit input	256-position	512-position	Solenoid mode 1	Solenoid mode 2
	Step data count	64 points	64 points	256 points	512 points	7 points	3 points
	Data input/output method	PC setup tool D-STEP or Digital operator TDO					
Input/output	Dedicated input/output	Input point	16 points (Start, Return to home position, Pause, Reset, Servo ON, Specify step number, etc.)*				
		Output point	16 points (Return to home position completed, In position, Servo ready, Alarm, Emergency stop status, etc.)*				
	Input/output power supply	24V DC ±10% (This should be prepared by yourself.)					
Communication	Serial communication	Connected device	PC setup tool D-STEP or Digital operator TDO				
		Communication method	RS-485				
		Port count	Mini DIN × 1				
Usage conditions	Usage conditions	0 to 40°C (No freezing)/-20 to 85°C (No freezing)					
	Operating humidity/Storage humidity	90% RH or below (No condensation)					
	Ambient condition	Indoor (Free from direct sunlight, corrosive gas, flammable gas, oil mist, dust, water, oil and chemicals)					
General specifications	Protective function	Overload, overvoltage, excessive position deviation, software limit over error, etc.					
	Accessories	Power supply connector × 1 I/O connector × 1					
	Options (sold separately)	Digital operator TDO (Cable length 5 m) I/O cable 3m, 5m, 7m, and 10m PC communication cable (Mini DIN ↔ USB)					
	Outer dimensions	32mm (W) × 192.2mm (H) × 77.6mm (D)					
	Weight	300g or less					

* Varies depending on function mode.

System Configuration

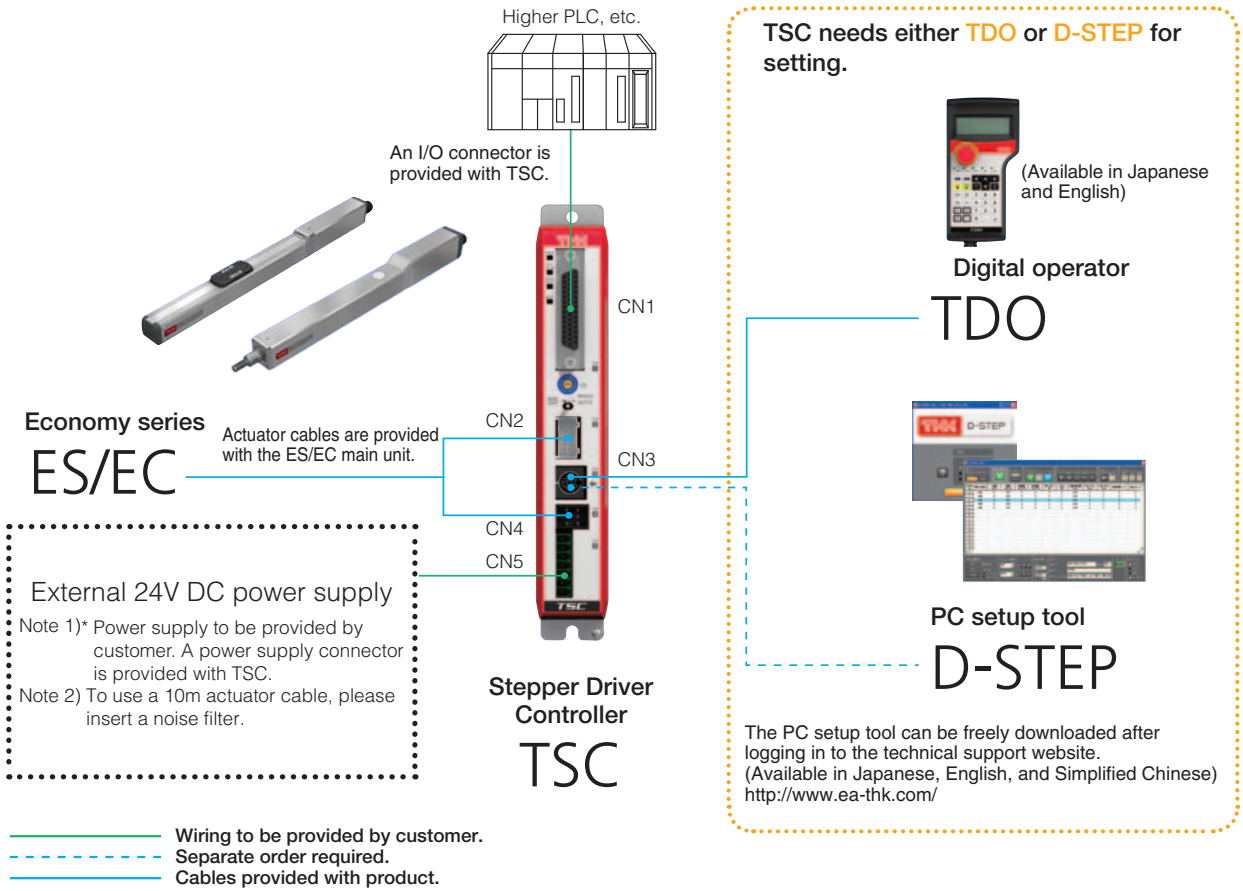

Dimensional Drawing of Controller

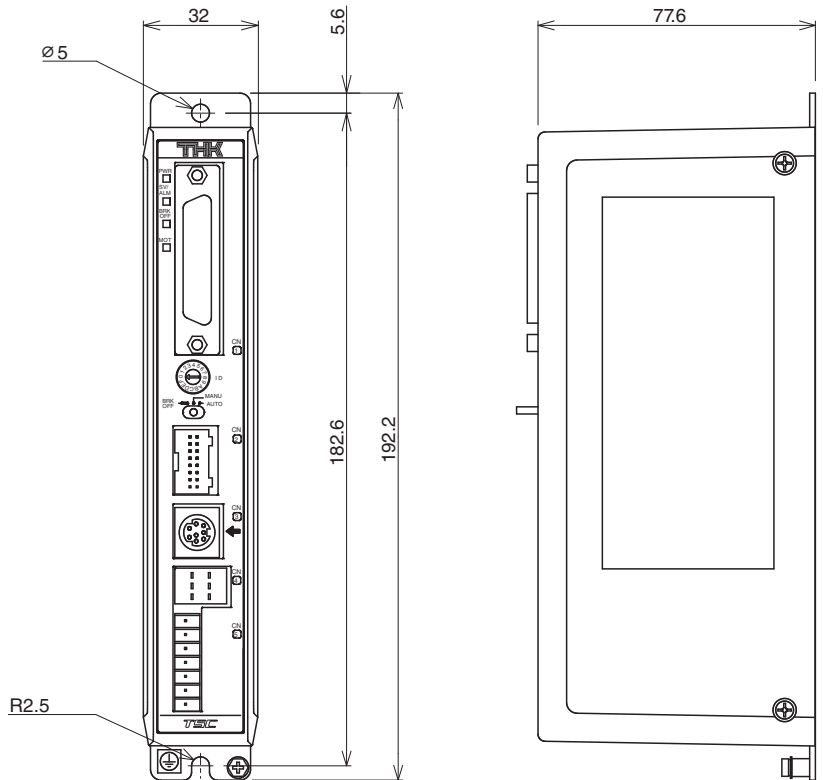

* For details of the dimensional drawing, please contact THK.

TSC Pin Configuration

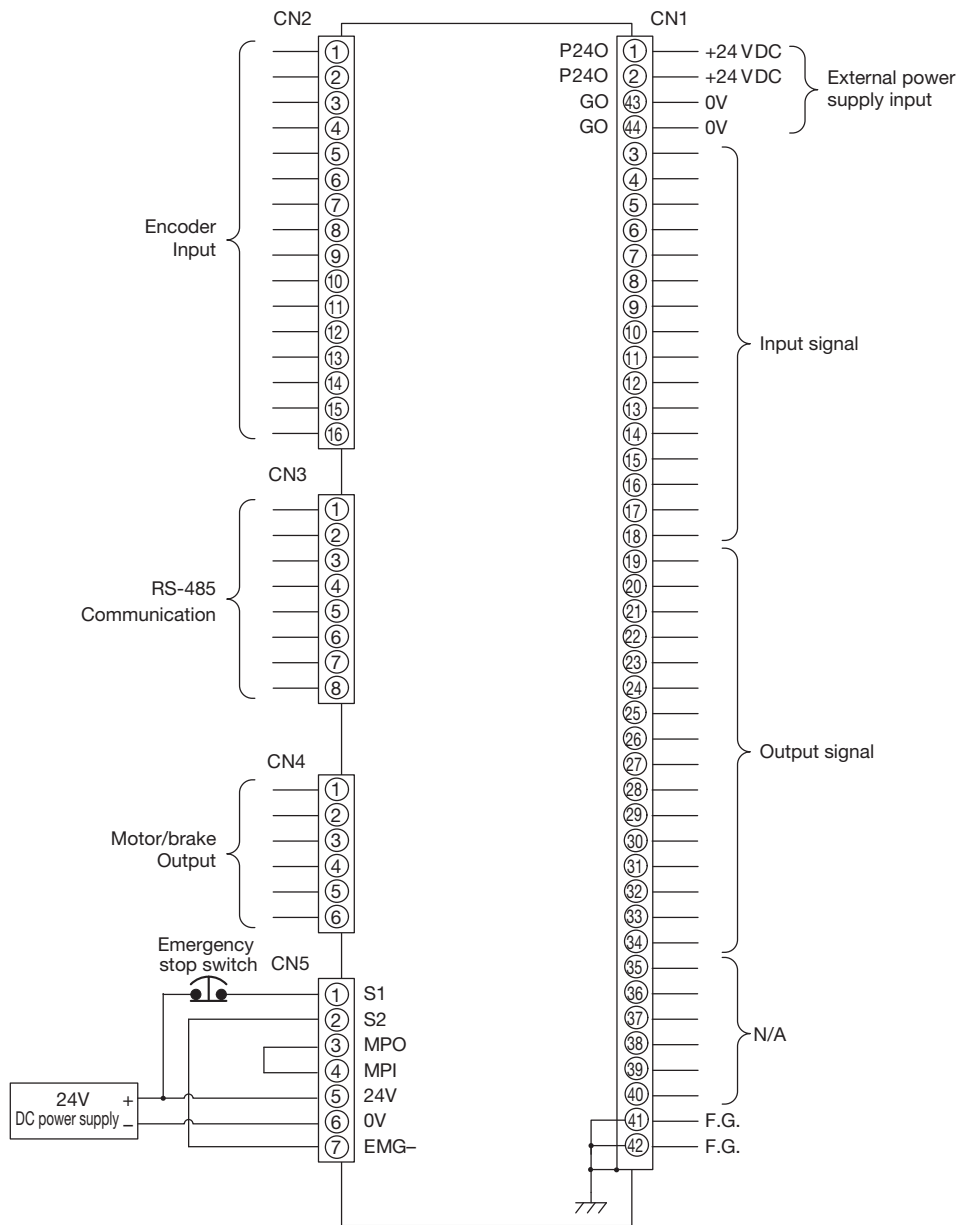

For attached I/O connector pin numbers, see P.46.
 Customer provides 24V DC power supply for input/output circuitry.

Input/Output Circuitry for TSC (CN1)

Input circuit

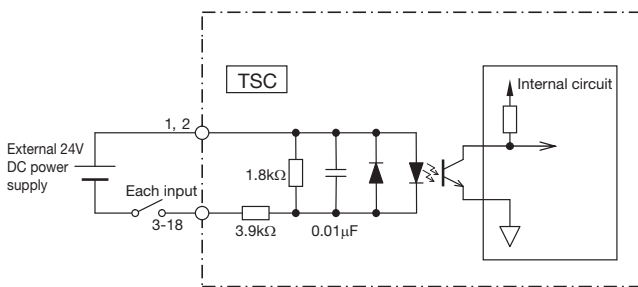

Output circuit

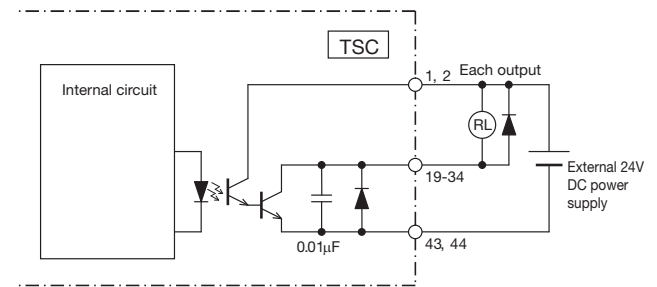

TSC Function Modes

TSC provides six modes to support various requirements and purposes.

Function mode		Overview	Step data count	Pressing operation
Multi-point positioning	0: 64-position	Multi-point positioning operation with 64 points With area output, with P area output	64	○
	1: External unit input instruction	Multi-point positioning operation with 64 points I/O-based external unit instruction mode Without area output, with P area output	64	–
	2: 256-position	Multi-point positioning operation with 256 points Without area output, with P area output	256	○
	3: 512-position	Multi-point positioning operation with 512 points Without area output, without P area output	512	○
Electromagnetic valve	4: Solenoid mode 1	Multi-point positioning operation with 7 points Direct move command input With area output, with P area output	7	○
	5: Solenoid mode 2	Multi-point positioning operation with 3 points Direct move command input With position sensor auto-switch output, area output and P area output	3	–

Pin Configuration by Function Mode

I/O	CN1 pin number	Signal name						
		Function mode 0 64-position	Function mode 1 External unit input	Function mode 2 256-position	Function mode 3 512-position	Function mode 4 Solenoid mode 1	Function mode 5 Solenoid mode 2	
Input	3	PI 0	PI 0	PI 0	PI 0	ST 0	ST 0	
	4	PI 1	PI 1	PI 1	PI 1	ST 1	ST 1	
	5	PI 2	PI 2	PI 2	PI 2	ST 2	ST 2	
	6	PI 3	PI 3	PI 3	PI 3	ST 3	–	
	7	PI 4	PI 4	PI 4	PI 4	ST 4	–	
	8	PI 5	PI 5	PI 5	PI 5	ST 5	–	
	9	–	MODE	PI 6	PI 6	ST 6	–	
	10	–	JOG/INCHING	PI 7	PI 7	–	–	
	11	–	JOG P	–	PI 8	–	–	
	12	BKRL	JOG N	BKRL	BKRL	BKRL	BKRL	
	13	STRT	STRT/PWRT	STRT	STRT	–	–	
	14	MANU	MANU	MANU	MANU	MANU	MANU	
	15	HOME	HOME	HOME	HOME	HOME	HOME	
	16	PAUSE	PAUSE	PAUSE	PAUSE	PAUSE	PAUSE	
	17	REST	REST	REST	REST	REST	REST	
	18	SV-ON	SV-ON	SV-ON	SV-ON	SV-ON	SV-ON	
	Output	19	PO 0	PO 0	PO 0	PO 0	PE 0	LS 0
		20	PO 1	PO 1	PO 1	PO 1	PE 1	LS 1
21		PO 2	PO 2	PO 2	PO 2	PE 2	LS 2	
22		PO 3	PO 3	PO 3	PO 3	PE 3	–	
23		PO 4	PO 4	PO 4	PO 4	PE 4	–	
24		PO 5	PO 5	PO 5	PO 5	PE 5	–	
25		MOVE	MOVE	PO 6	PO 6	PE 6	–	
26		AREA	MODES	PO 7	PO 7	AREA	AREA	
27		P AREA	P AREA	P AREA	PO 8	P AREA	P AREA	
28		MANU S	MANU S	MANU S	MANU S	MANU S	MANU S	
29		HEND	HEND	HEND	HEND	HEND	HEND	
30		INPS	INPS	INPS	INPS	INPS	–	
31		LOAD/TRQS	WEND	LOAD/TRQS	LOAD/TRQS	LOAD/TRQS	–	
32		SVRDY	SVRDY	SVRDY	SVRDY	SVRDY	SVRDY	
33		EMGS	EMGS	EMGS	EMGS	EMGS	EMGS	
34		ALM	ALM	ALM	ALM	ALM	ALM	

Input Signal Functions

Input		
Signal name	Description	Remarks
MANU	Operation mode	Switches AUTO/MANUAL from I/O. MANUAL when signal is on, and AUTO when it is off.
STRT	Start	Start signal of program step. Program starts when signal is on.
PI0 - PI8	Instruction position number	Input for specifying position numbers. Specifies programs at each signal level. Selects a program step and starts a program with "STRT" signal.
PAUSE	Pause	Temporarily interrupts the operation. PAUSE input status when signal is off. (N.C. connection specification)
HOME	Return to home position	Starts the return to home position operation. Returning to home position is started when signal is on. It stops when it is off.
SV-ON	Servo on	Turns the servo ON and OFF. Servo ON when signal is on, and servo OFF when signal is off.
REST	Alarm reset	Resets alarm. Resets remaining travel distance during pause. Resets when it is on.
BKRL	Brake release	Forcibly releases brake. Releases brake when it is on.
MODE	External unit input instruction mode	Enters the instruction mode when signal is on. Instruction mode when signal is on.
PWRT	Current position write with external unit input instruction	During the instruction mode, the position is written when this signal is greater than 20ms with the position for writing specified.
JOG/INCHING	Manual operation switch with external unit input instruction	Switching of manual operation during the instruction mode. Selects inching operation when it is on, and jog operation when it is off.
JOG P	Moving direction + with external unit input instruction	Operating direction and operation start signal during the instruction mode. Moves in + direction to the soft limit when signal is on. Decelerates and stops when it is off while moving.
JOG N	Moving direction - with external unit input instruction	Operating direction and operation start signal during the instruction mode. Moves in - direction to the soft limit when signal is on. Decelerates and stops when it is off while moving.
ST0 - 6	Cylinder type START	Program start signal for position numbers from ST0 to ST6. Can select either Level or Edge for signal using parameter 13 "move" command. Note that when more than two positions are on at the same time, the lowest-number signal takes precedence.

Output Signal Functions

Output		
Signal name	Description	Remarks
MANU S	Operation mode status	Operation mode status outputs (AUTO/MANUAL). MANUAL when signal is on, AUTO when off.
PO1 - PO8	End position number	Outputs the position number arrived after positioning is completed (binary outputs).
MOVE	Moving	Outputs signal during motor operation.
INPS	Positioning completed	Outputs when motor comes within the positioning completed width.
SVRDY	Operation preparations completed	Outputs signal when servo is on.
ALM	Alarm	Alarm output signal.
MODES	Operation mode status	Output signal for judging instruction mode or regular operation mode. Instruction mode when signal is on. Regular operation mode when it is off.
WEND	Writing completed	Signal is off after switching to the regular mode, and it is on for 30ms when writing of the PWRT signal is completed.
HEND	Return to home position completed	Outputs signal when returning to home position is completed.
AREA	Upper/lower area limit	On when the current position of actuator is within a range specified by the parameter.
P AREA	Position area	On when the current position of actuator is within a range specified by the program step.
EMGS	Emergency stop status	Outputs judgment for input of emergency stop. On during normal operation, and off when emergency stop circuit is shut off.
LOAD	Load output judgment status	On when a directive torque exceeds the threshold over a certain period within a judgment range.
TRQS	Torque level status	On when the load threshold is reached while moving. Off while the load remains under the threshold.
PE0 - PE6	Cylinder type arrival completed output	Signal generated after operation for position number is completed.
LS0 - LS2	Cylinder type position detection output	Outputs when the current position comes within the positioning width for each of the three points.

I/O Connector Pin Numbers

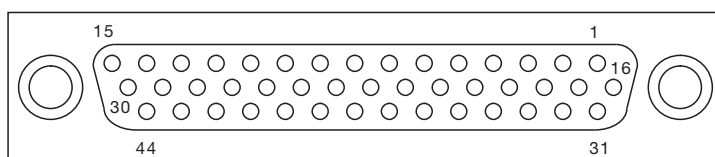

Controller connector port view

Controller Series
Network Unit

TNU

Fieldbus-compatible multiple-axis connection



Less Wiring Required

Connecting to a PLC through a fieldbus network requires less wiring than an I/O cable connection. In addition, the network unit and each driver controller can be connected with a single dedicated cable.



Up to 16 Axes Can Be Connected

Up to 16 axes of mixed THK driver controllers (TLC and THC) can be connected using one TNU and TJU (branch unit) in combination.

System Configuration

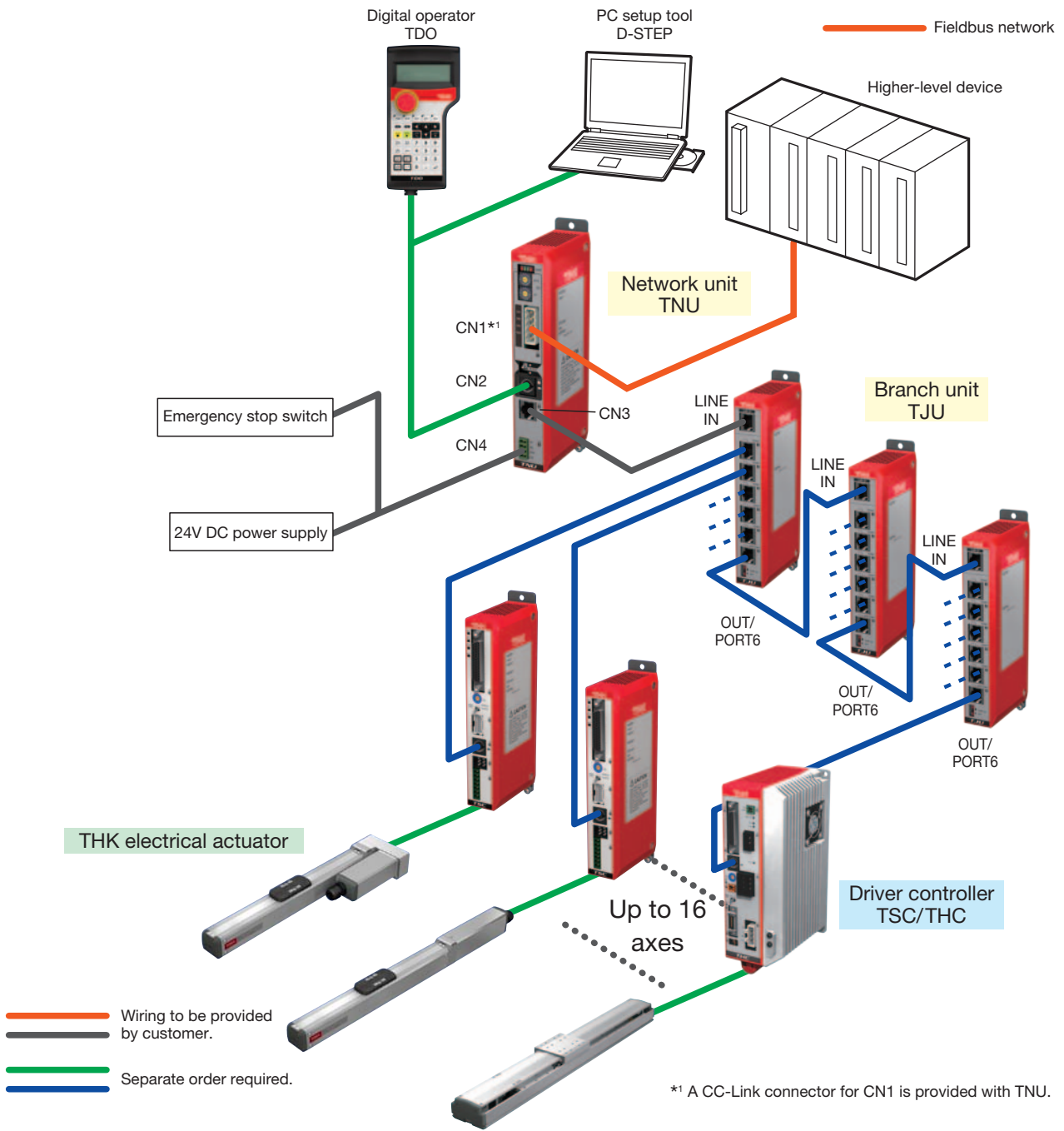

Model Configuration

● Network unit

Model	Network type
TNU	CC
(1)	(2)
TNU	CC: CC-Link
	EC: Ether CAT

● Branch unit

Model
TJU
(1)
TJU

● TACnet cable (between TJU and driver controller)

Model	Type	Cable length
CBL	NW	01
(1)	(2)	(3)
CBL	NW	01: 1m
		03: 3m

Use an industrial Ethernet cable between TNU and TJU, and between TJUs.

Specifications

Type		TNU-CC	TNU-EC
Fieldbus	Communication standard	CC-Link Ver1.1	Ether CAT
	Communication speed [bps]	10M/5M/2.5M/625k/156k	100M
	Number of occupied stations	Four remote device stations	-
Applicable controller		TLC, THC	
THK network	Transmission channel type	RS-485	
	Communication speed [bps]	38.4k/57.6k/115.2k	
	Communication method	Half duplex	
	Maximum trunk length [m]	20	
	Maximum number of connectable axes	16	
Input power supply		24V DC $\pm 10\%$, up to 0.3A	
Operating/storage temperature [°C]		0 to 40°C (No freezing)/-20 to 85°C (No freezing)	
Operating/storage humidity [RH %]		90 or below (No condensation)	
Ambient condition		Indoor (Free from direct sunlight, corrosive gas, flammable gas, oil mist, dust, water, oil and chemicals)	
Protective function		Higher-level network communication error, communication error, system error	
Weight [g]		240 (TJU: 220)	

Dimensions

● TNU

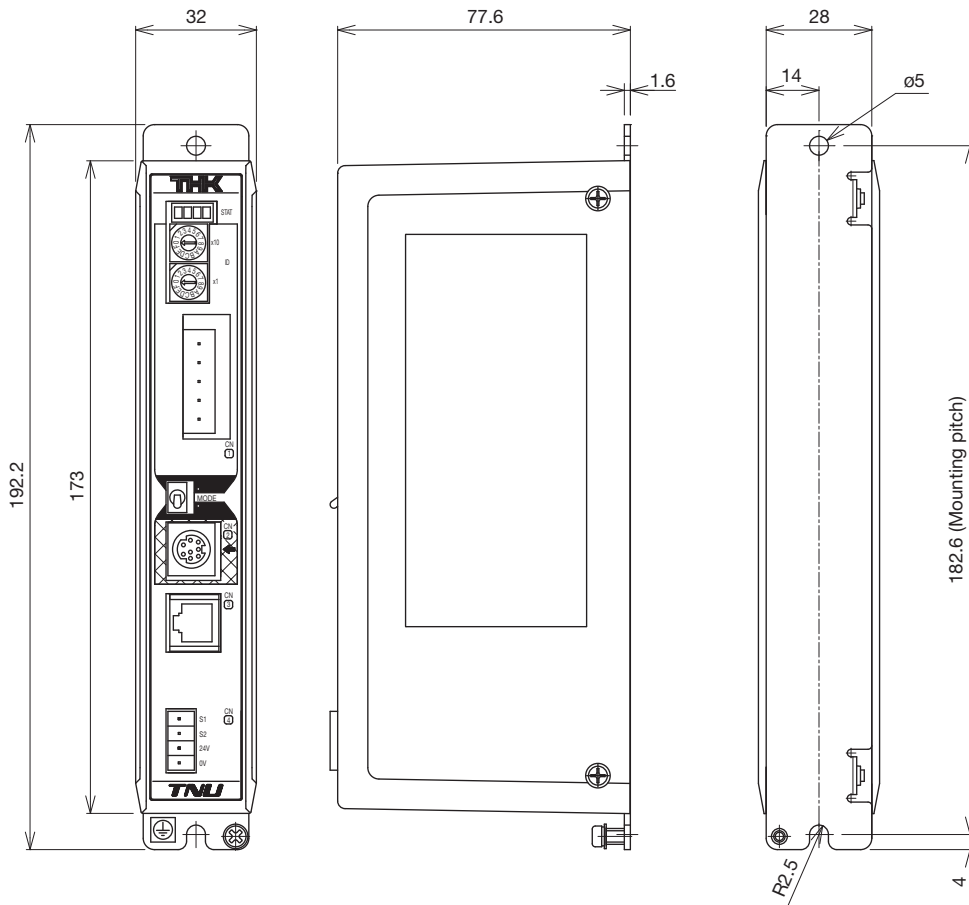

● TJU

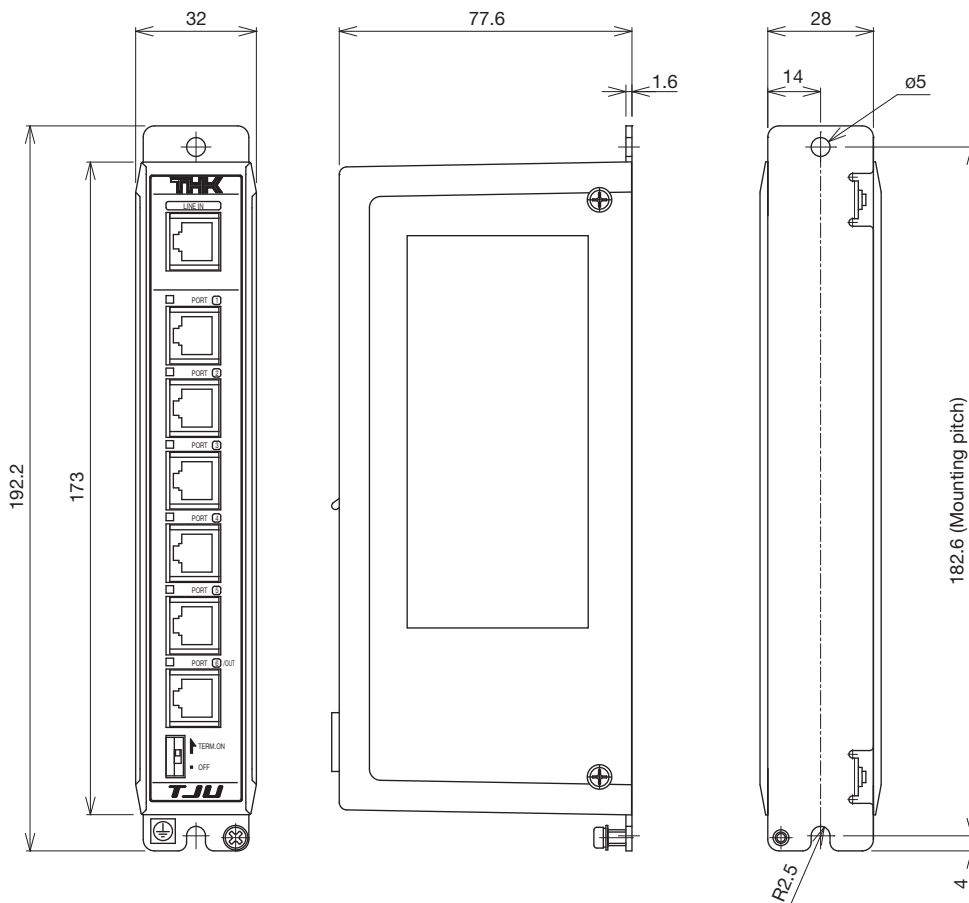

The external dimensions and mounting dimensions of TNU and TJU are the same.

Components

● TNU

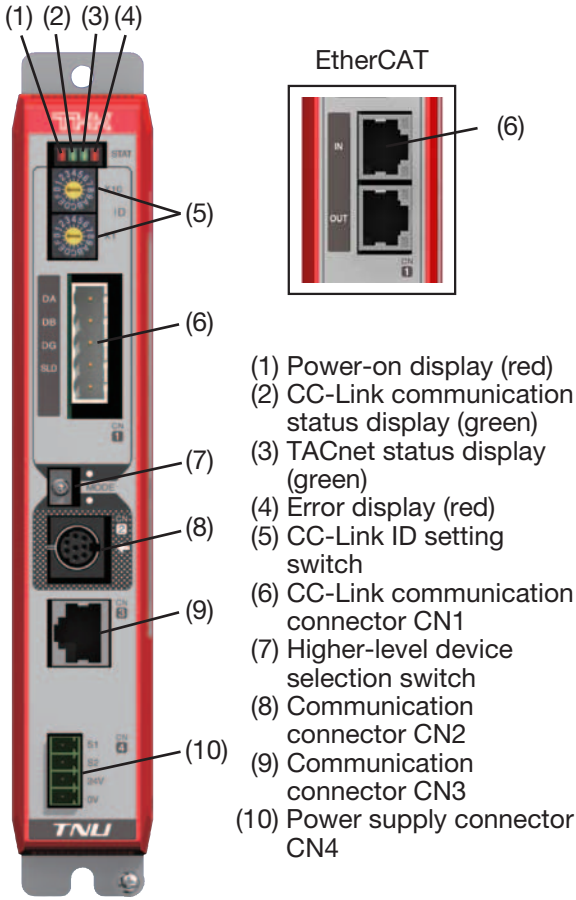

● TJU

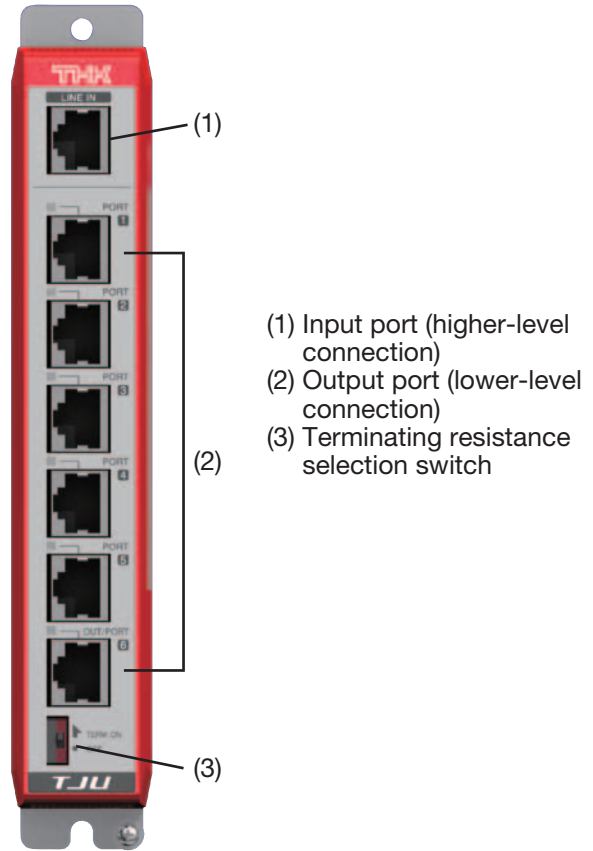

External Device Connection (TNU)

● CC-Link

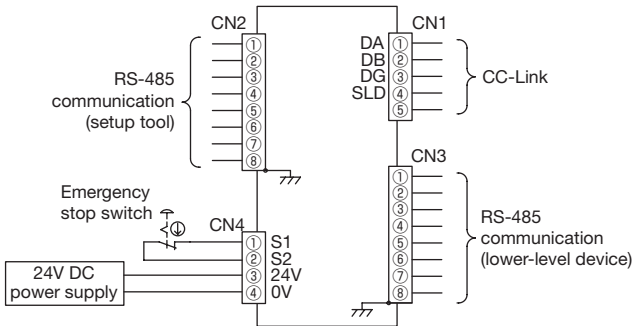

● EtherCAT

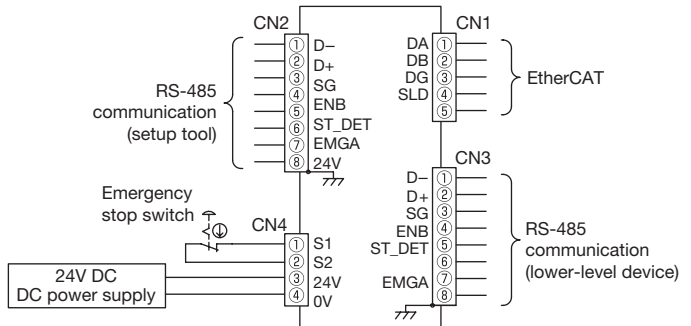

Note: The emergency stop terminals (CN4-S1 and S2) are not used for power shutdown of TNU, but used for an emergency stop of the lower-level device (THK driver controller).

TDO Digital operator (separate order required)**Features**

Simple, quick operations and settings of TSC, TLC and THC are possible without using a PC.

Simple Operation

Key sheet with a straightforward design,
LC with backlight (20 digits × 4 lines).

Functions

- Checking and editing step data and parameters
 - Operation of actuator
(Return to home position, Jog operation, Inching operation, Program execution, Servo ON/OFF, Electromagnetic brake ON/OFF)
 - Monitor (I/O, Current position, Position command, Current command, Version display)
 - Alarm (History display, Clear history, Interrupt display on occurrence, Alarm reset)
 - Settings (Backlight luminance, LCD contrast, Beep tone, Automatic turn off of backlight)
 - Enable switch (3 positions) - Protection structure IP54 (excluding cable connectors) - Display language (Japanese/English)
- External dimensions: 110mm (W) × 218.3mm (H) × 66.6mm (D) (excluding crests)
Main unit weight: 400g (excluding cables) Cable length: 5m
TLC/THC is supported with Version 1.03 or later.
TNU is supported with Version 1.10 or later.

Model Configuration

Model	Type
TDO	N
(1)	(2)
TDO	N: Category 2* compliant type

* ISO 13849-1

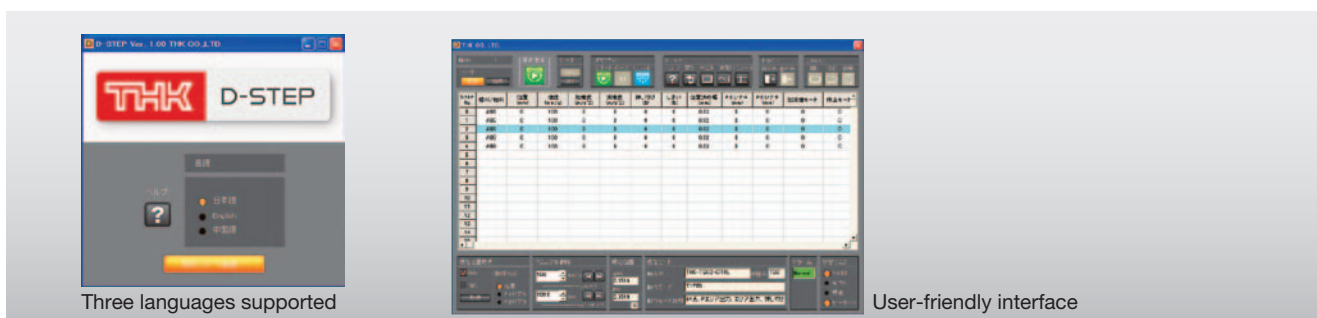
D-STEP PC setup tool

Three languages supported

User-friendly interface

Features

Supports multifunctional TSC/TLC/THC with user-friendly interface.

Simple Operation

Operations and settings of TSC, TLC and THC are possible using a PC.
Equipped with functions useful for maintenance, such as backing up data or logging operating states.

Functions

- Checking, editing, backing up, or offline-editing of step data
 - Checking, editing, backing up, or offline-editing of parameters
 - Operations of actuator (Return to home position, Jog operation, Inching operation, Program execution, Servo ON/OFF)
 - Monitor (I/O, Current position, Position command, Current command) - Logging (Speed and current waveform display)
 - Alarm (History display, Clear history, Alarm reset) - Display language (Japanese/English/Simplified Chinese)
- Supported OS: Windows XP/Windows Vista/Windows 7
D-STEP can be freely downloaded from the THK technical support website (<https://tech.thk.com/>).
TLC/THC/TNU is supported with Version 1.10 or later.

Cable

I/O cable: CBL TSC IO ** (optional)

** indicates cable length: 03 (3m), 05 (5m), 07 (7m), or 10 (10m).

Cables are shipped with the discrete wire side terminals unprocessed.

Cables are used for TSC/TLC/THC.

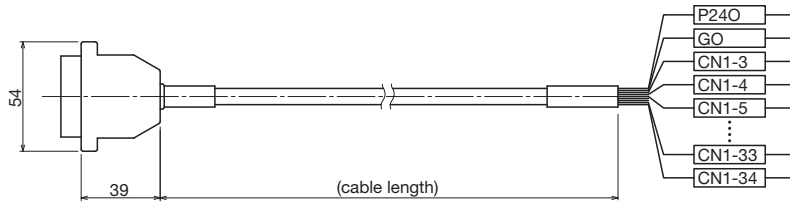

PC communications cable: CBL-COM-03 (optional)

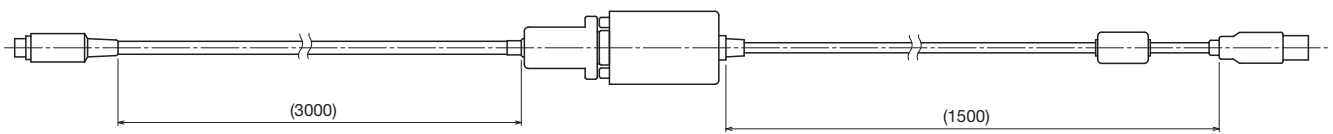



Precautions on Use

● Application

- This product cannot be applied to any equipment or system that may be used under a life-threatening condition.
- When you consider using this product for special applications such as equipment/system for mobile vehicles, medical uses, aerospace, atomic energy and power plants, make sure to contact THK for applicability beforehand.

● Safety Precautions

- Before operation, please read thoroughly and obey "Manipulating industrial robots – Safety" (JIS B8433) and "Ordinance on Industrial Safety and Health" (Ministry of Health, Labor and Welfare).
- Read the manual carefully, understand the contents well, and strictly observe the safety precautions.
- Before performing installation, adjustment, checking, or services regarding the main actuator unit, controller and the relevant connected equipment, make sure to remove all power plugs from the outlet and apply locking or safety plugs so that nobody else can turn on the power. Also display a signboard showing that the work is ongoing at a prominent place.
- Do not touch the moving part of the actuator while it is energized. In addition, do not enter the operating area of the actuator while the product is operating or in the ready state.
- If two or more people are involved in the operation, confirm the procedures such as a sequence, signs and anomalies in advance, and appoint another person for monitoring the operation.
- Do not unnecessarily disassemble this product. Doing so may allow foreign materials to enter or deterioration of precision. Also this will cause the risk of electric shock from the controller.
- Take care not to drop or strike this product. Doing so may cause injury or damage the unit. If the product is dropped or impacted, functionality may be reduced even if there is no surface damage.
- Operation of the actuator over the permissible rotational speed may cause damage or an accident. Please keep the rotational speed within THK specifications.
- Prevent foreign material, such as dust or cutting chips, from entering the product. This could cause damage to ball recirculation components and loss of functionality.
- When planning to use the product in an environment where a coolant could penetrate the unit, contact THK.
- When there is any risk that the slider may collide with the stoppers attached to both ends of operable range, install some shock absorbing mechanism such as a shock absorber. The stoppers are not designed to absorb the impact generated by the collision of the slider. When the slider collides with a stopper during operation, it may cause damage or an accident.

● Environment

- An indoor location and ambient temperatures from 0 to 40°C, and humidity of 80%RH or below (no freezing or condensation).

Wrong environment can cause failures of the actuator and driver. The best place to use the product is as follows:

- A place free from corrosive gas and flammable gas.
- A place where vibration or impact is not transmitted to the unit.
- A place free from electrically conductive powder (such as iron powder), dust, oil mist, cutting fluid, moisture, salt, and organic solvent.
- A place free from direct sunlight and radiant heat.
- A place free from strong electric and magnetic fields.
- A place that is easily accessible for service and cleaning purposes.
- When using the product in locations exposed to constant vibrations or in special environments such as vacuum or abnormally high or low temperatures, contact THK in advance.

● Mounting Surface

- The surface should be the plane that has the precision of machining or the equivalent of that. Some products specify the required flatness. When you wish to use the product with QZ in a position other than horizontal (such as wall mount and vertical posture), contact THK.

● Lubrication

- In order to effectively use the actuator, lubrication is required. Insufficient lubrication may increase abrasion on the rolling part and cause early failure.
- Do not use a mix of lubricants with different physical properties. Note that encapsulated lubricant types vary depending on products.
- Please contact THK if using special lubricants.
- THK recommend the greasing interval to be approximately every 100km. However, it may vary depending on the usage conditions, so THK recommends determining a greasing interval during the initial inspection.
- If the product is to be used in location exposed to vibrations or in special environment such as vacuum, or abnormally high or low temperatures, or in a clean room, normal lubricants may not be used. Contact THK for details.
- When adopting oil lubrication method, contact THK.

● Storage

- When storing this actuator, enclose it in a package designated by THK and store it in a horizontal position away from abnormally high or low temperatures and high humidity.

● Instruction Manual

- Instruction Manuals can be downloaded from the website (a login process may be required).
THK Technical Support site <https://tech.thk.com/>
"Economy series ES/EC Instruction Manual"
and other contents including CAD data and PC software (D-STEP) can also be downloaded.



Economy Series ES/EC

- LM Guide, and  are registered trademarks of THK CO., LTD.
- The actual products may differ from the pictures and photographs in this catalog.
- Outward appearances and specifications are subject to change without notification for the purpose of improvement.
- Although great care has been taken in the production of this catalog, THK will not take any responsibility for damage resulting from typographical errors or omissions.
- In exporting our products and technology, or selling them for the purpose of export, THK has a basic policy of observing laws relating to foreign exchange, trade and other laws. For export of THK products as single items, please contact THK in advance.

All rights reserved.

THK CO., LTD.

HEAD OFFICE 3-11-6 NISHI-GOTANDA, SHINAGAWA-KU, TOKYO 141-8503 JAPAN
INTERNATIONAL SALES DEPARTMENT PHONE:+81-3-5434-0351 FAX:+81-3-5434-0353

Global site : <http://www.thk.com/>

NORTH AMERICA

THK America, Inc.

● HEADQUARTERS

Phone: +1-847-310-1111 Fax: +1-847-310-1271

● CHICAGO OFFICE

Phone: +1-847-310-1111 Fax: +1-847-310-1182

● NORTH EAST OFFICE

Phone: +1-631-244-1565 Fax: +1-631-244-1565

● ATLANTA OFFICE

Phone: +1-770-840-7990 Fax: +1-770-840-7897

● LOS ANGELES OFFICE

Phone: +1-949-955-3145 Fax: +1-949-955-3149

● SAN FRANCISCO OFFICE

Phone: +1-925-455-8948 Fax: +1-925-455-8965

● DETROIT OFFICE

Phone: +1-248-858-9330 Fax: +1-248-858-9455

● TORONTO OFFICE

Phone: +1-905-820-7800 Fax: +1-905-820-7811

SOUTH AMERICA

THK BRAZIL INDUSTRIA E COMERCIO LTDA.

Phone: +55-11-3767-0100 Fax: +55-11-3767-0101

EUROPE

THK GmbH

● EUROPEAN HEAD QUARTERS

Phone: +49-2102-7425-555 Fax: +49-2102-7425-556

● DÜSSELDORF OFFICE

Phone: +49-2102-7425-0 Fax: +49-2102-7425-299

● STUTTGART OFFICE

Phone: +49-7141-4988-500 Fax: +49-7141-4988-888

● U.K. OFFICE

Phone: +44-1384-47-1550 Fax: +44-1384-47-1551

● ITALY OFFICE

Phone: +39-02-9901-1801 Fax: +39-02-9901-1881

● SWEDEN OFFICE

Phone: +46-8-445-7630 Fax: +46-8-445-7639

● AUSTRIA OFFICE

Phone: +43-7229-51400 Fax: +43-7229-51400-79

● SPAIN OFFICE

Phone: +34-93-652-5740 Fax: +34-93-652-5746

● TURKEY OFFICE

Phone: +90-216-362-4050 Fax: +90-216-569-7150

● PRAGUE OFFICE

Phone: +420-2-41025-100 Fax: +420-2-41025-199

● MOSCOW OFFICE

Phone: +7-495-649-80-47 Fax: +7-495-649-80-44

THK Europe B.V.

● EINDHOVEN OFFICE

Phone: +31-040-290-9500 Fax: +31-040-290-9599

THK France S.A.S.

Phone: +33-4-3749-1400 Fax: +33-4-3749-1401

CHINA

THK (CHINA) C.O.,LTD.

● HEADQUARTERS

Phone: +86-411-8733-7111 Fax: +86-411-8733-7000

● SHANGHAI OFFICE

Phone: +86-21-6219-3000 Fax: +86-21-6219-9890

● BEIJING OFFICE

Phone: +86-10-8441-7277 Fax: +86-10-6590-3557

● CHENGDU OFFICE

Phone: +86-28-8526-8025 Fax: +86-28-8525-6357

● GUANGZHOU OFFICE

Phone: +86-20-8523-8418 Fax: +86-20-3801-0456

● SHENZHEN OFFICE

Phone: +86-755-2642-9587 Fax: +86-755-2642-9604

● XIAN OFFICE

Phone: +86-29-8834-1712 Fax: +86-29-8834-1710

THK (SHANGHAI) C.O.,LTD.

Phone: +86-21-6275-5280 Fax: +86-21-6219-9890

TAIWAN

THK TAIWAN CO.,LTD.

● TAIPEI HEAD OFFICE

Phone: +886-2-2888-3818 Fax: +886-2-2888-3819

● TAICHUNG OFFICE

Phone: +886-4-2359-1505 Fax: +886-4-2359-1506

● TAINAN OFFICE

Phone: +886-6-289-7668 Fax: +886-6-289-7669

KOREA

SEOUL REPRESENTATIVE OFFICE

Phone: +82-2-3468-4351 Fax: +82-2-3468-4353

SINGAPORE

THK LM SYSTEM Pte. Ltd.

Phone: +65-6884-5500 Fax: +65-6884-5550

THAILAND

THK LM System Pte.Ltd.Representative Office in Thailand

Phone: +660-2751-3001 Fax: +660-2751-3003

INDIA

THK India Pvt. Ltd.

Phone: +91-80-2340-9934 Fax: +91-80-2340-9937