



SEALLESS

DRUM PUMPS PP

FOR AGGRESSIVE LIQUIDS
THE RIGHT DRUM PUMPS



- This saves maintenance costs
- This avoids malfunctions
- This saves time
- This saves money

The most popular model for the most applications in drums and containers and technical objects...



PP drum pumps...



...for acids and bases.



are the basis ...



Advantages for the reliability

This saves maintenance costs

- robust coupling
- strong shaft
- stainless steel for stressed parts
- new development without seal



Advantages for the operational safety

This avoids malfunctions

- optional magnetic clutch for hermetical sealed pump
- strong connection motor-pump



Advantages for the user

This saves time

- quick release coupling
- no problems with failed threads



Advantages for the customer

This saves money

- one supplier for the most applications
- one motor for all types of impeller
- less equipment required

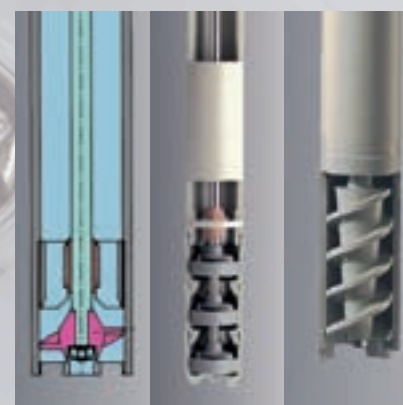



DRUM PUMPS PP

FOR AGGRESSIVE LIQUIDS
THE RIGHT DRUM PUMPS

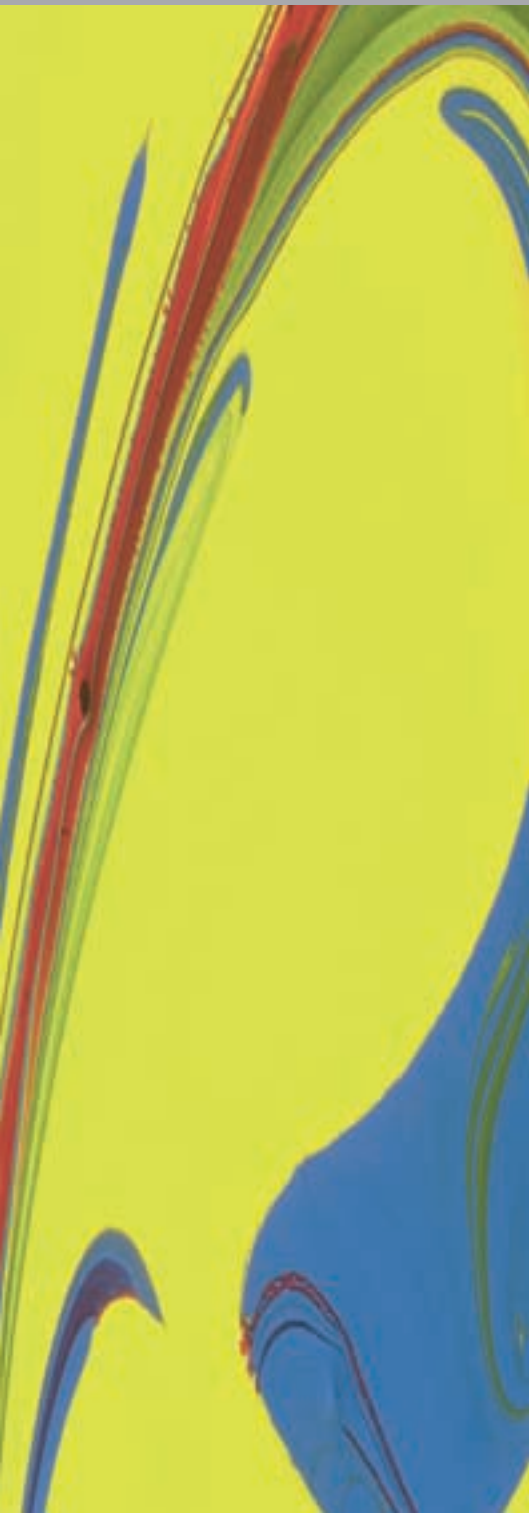

SEALLESS

- acids, low concentrated
- bases, low concentrated
- colours
- emulsions
- dispersions
- suspensions
- fluids of medium viscosity
- cosmetics



For aggressive* liquids...

Versions A, R column 1-2, page 7

If the liquid has to be mixed...

Series MP
Versions A, R column 4, page 7

For liquids of medium viscosity...

Version S column 3, page 7

SL-PP:

For transfilling and draining of drums and containers.

The perfect drum pump for the most thin liquids. Version A for high flow rate, Version R for high pressure, with foot valve for complete drainage.

Recommendation:

SL-PP-R-HC with motor p400-A.

*with drive shaft hastelloy C (HC) there are no problems with aggressive liquids

SL-MP-PP:

For stirring of emulsions, dispersions, suspensions, etc. before starting the transfilling action.

The mixing drum pump is fitted with mixing apertures. By moving a sliding sleeve with a lever, these holes can be opened or closed.

„Open“ is for mixing inside the drum and „closed“ is for pumping out of the drum. All this can be achieved with one unit.

Recommendation:

For a good stirring effort use the powerful motor p400-A.

SL-PP-S:

The feed screw (S) is dedicated for liquids of medium viscosity ($\eta > 200$ mPas), if the impeller types A and R reach their limitations.

With induction motor ideal combination for gentle dealing with the liquid.

Recommendation:

Induction motor with frequency inverter for variable flow rate.

Sealless pumping units

Sealless pump tubes from grün are reliable without using a mechanical seal and are suitable for almost any aggressive, low viscosity media. Our sealless pumping units are available in PP, PVDF, stainless steel (SS) and aluminium (Alu) material versions.

(Separate brochure for each material available).

Design PP:

The pump tube (3) is divided by the inner tube into sections to separate the fluid under pressure (3 flow channels) and the low pressure section (wave channel).

Advantages of sealless drum pumps

- ▶ Cleaning the pumping unit is greatly facilitated; the risk of fluid carry-over when moving the pump to a different container is minimized.

- ▶ The build-in webs add considerable rigidity to the pump tube, resulting in greatly improved mechanical stability of the pumping unit.

- ▶ No bearings in the wave channel.

- ▶ Motor power is transferred by proven, robust coupling (1) with curved teeth over the stainless steel coupling element (2) with a large double bearing.

- ▶ Of course, the sealless pump tubes are fully compatible with the sealed models, allowing you to use the pumping units with any motor from grün product range.

- ▶ Depending on the application you can select one of 3 different types of impellers: axial (A), radial (R) and feed screw (S).

Product profile

A drum pump always consists of a pump tube and a motor. These components are connected by means of a quick coupling. Any pump tube can be used with any motor.

Selecting the right order-no.

In the general order-no., for example 500-00XX, fill in the specific numbers for your choice. Example: Order-No. p310-A 230V: 500-0017
SL-PPA-SS-1000 (SS drive shaft): 670-0002
SL-PPA-HC-1200 (HC drive shaft): 670-0006



- **optimised in price**
- **short and occasional usage**
- **it likes light and thin liquids**
- **opt. LVR: low voltage release for advanced safety**
- **opt. SR: speed reducer for simple flow rate variation**

Motor		Pump tube
p310		Performance curve
		Hydr. Values
Power (W)	520	Capacity Q (l/min)
Voltage (V)	230 / 120	Delivery head H (mWS)
Protection	IP 24	Density ρ (kg/l)
LVR*	optional	Viscosity η (mPas)
Weight (kg)	3,5	Weight (kg)
		Temperature (°C)
Order-No.	500-00XX	L (mm)
Voltage (V)	230 120	
p310 (LVR)	16 28	700
p310-A	17 29	1000
p310-A-SR	54 -	1200



- **the ideal drive**
- **big resources in power and durability**
- **quick working and saving time**
- **opt. LVR: low voltage release for advanced safety**
- **opt. SR: speed reducer for simple flow rate variation**
- **opt. IP 54: 230V**
- **Order-No. 500-0052**

Motor		Pump tube
p400		Performance curve
		Hydr. Values
Power (W)	850	Capacity Q (l/min)
Voltage (V)	230 / 120	Delivery head H (mWS)
Protection	IP 24	Density ρ (kg/l)
LVR*	optional	Viscosity η (mPas)
Weight (kg)	4	Weight (kg)
		Temperature (°C)
Order-No.	500-00XX	L (mm)
Voltage (V)	230 120	
p400 (LVR)	23 25	700
p400-A	24 26	1000
p400-A-SR	56 -	1200



- **the power drive**
- **variable speed**
- **starting knob fixable**
- **for heavy duty**
- **easy handling**
- **economical air consumption**

Motor		Pump tube
d600		Performance curve
		Hydr. Values
Power (W)	600	Capacity Q (l/min)
Pressure (bar)	3-7	Delivery head H (mWS)
Consumption of air (l/s)	10	Density ρ (kg/l)
Weight (kg)	1,7	Viscosity η (mPas)
		Weight (kg)
		Temperature (°C)
	Order-No.	L (mm)
d600	520-0016	700
		1000
		1200



- **the silent marathon worker**
- **ideal for viscous liquids**
- **smooth product treatment with feed screw**
- **voltage 230 V (1-ph) and 400 V (3-ph)**
- **opt.: with frequency inverter**
- **opt.: Ex-proof versions**

Motor		Pump tube
pd500		Performance curve
		Hydr. Values
Power (W)	see below	Capacity Q (l/min)
Voltage (V)	230 / 400	Delivery head H (mWS)
Protection	IP 54	Density ρ (kg/l)
Overload release	1-ph: yes 3-ph opt.	Viscosity η (mPas)
Weight (kg)	5	Weight (kg)
		Temperature (°C)
	Order-No.	L (mm)
pd500-1 370W	500-0042	700
pd500-3 370W	500-0039	1000
		1200

* LVR: Low voltage release (restart protection)

1		2		3		4		5	
SL-PP-A		SL-PP-R		SL-PP-S		SL-MP PP-A		SL-MP PP-R	
A100		R100				A100		R100	
max		max				max		max	
100		90				100		90	
6		14				6		14	
1,3		1,6				1,3		1,6	
300		250				300		250	
1,5		1,5				1,5		1,5	
50		50				50		50	
670-000X		675-000X				670-00XX		675-00XX	
SS	HC	SS	HC			SS	HC	SS	HC
1	4	1	4			19	22	37	40
2	5	2	5			20	23	38	41
3	6	3	6			21	24	39	42

1		2		3		4		5	
SL-PP-A		SL-PP-R		SL-PP-S		SL-MP PP-A		SL-MP PP-R	
A200		R200		S200		A200		R200	
max		max		max		max		max	
110		100		60		110		100	
8		20		10		8		20	
1,6		2		1,5		1,6		2	
800		700		700		800		700	
1,5		1,5		1,5		1,5		1,5	
50		50		50		50		50	
670-000X		675-000X		670-00XX		670-00XX		675-00XX	
SS	HC	SS	HC	SS	HC	SS	HC	SS	HC
1	4	1	4	09	13	19	22	37	40
2	5	2	5	19	14	20	23	38	41
3	6	3	6	11	15	21	24	39	42

1		2		3		4		5	
SL-PP-A		SL-PP-R		SL-PP-S		SL-MP PP-A		SL-MP PP-R	
A600		R600		S600		A600		R600	
max		max		max		max		max	
90		80		60		90		80	
6		11		6		6		11	
1,6		2		1,5		1,6		2	
800		700		700		800		700	
1,5		1,5		1,5		1,5		1,5	
50		50		50		50		50	
670-000X		675-000X		670-00XX		670-00XX		675-00XX	
SS	HC	SS	HC	SS	HC	SS	HC	SS	HC
1	4	1	4	09	13	19	22	37	40
2	5	2	5	19	14	20	23	38	41
3	6	3	6	11	15	21	24	39	42

1		2		3		4		5	
SL-PP-A		SL-PP-R		SL-PP-S		SL-MP PP-A		SL-MP PP-R	
				S500					
				max					
				60					
				6					
				1,5					
				1500 (min 100)					
				1,5					
				50					
				670-00XX					
				SS HC					
				09 13					
				19 14					
				11 15					

Other voltages on demand.

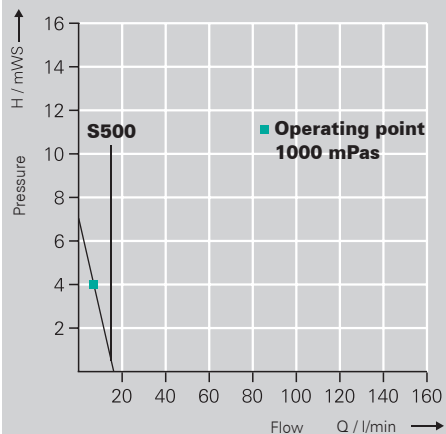
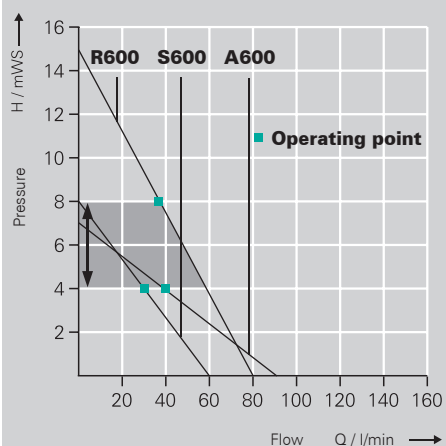
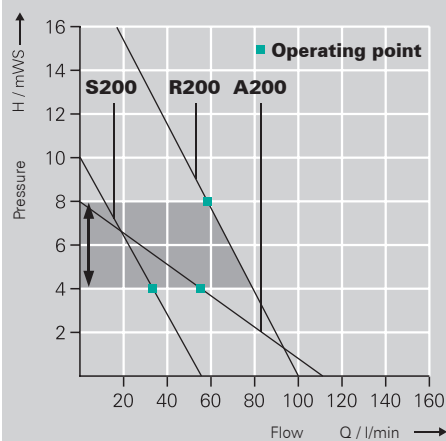
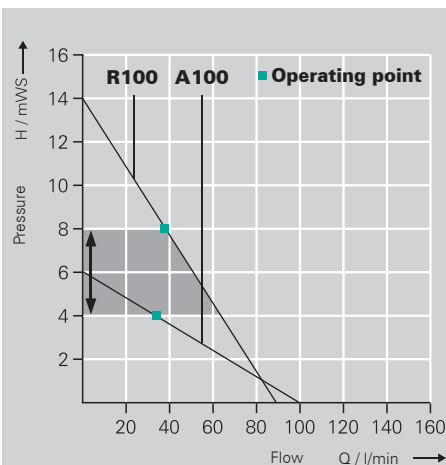
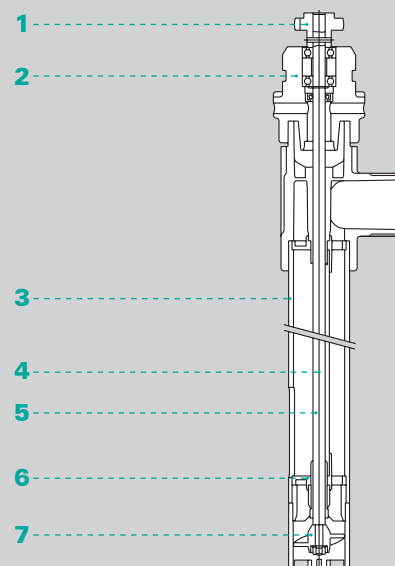

Table of materials

Description	Pump tube version
	PP
1. Curved teeth coupling	PA
2. Coupling element	PP/SS
3. Pump tube with flow and wave channel	PP
4. Drive shaft opt.	SS or HC
5. Wave channel	PP
6. Slide bearing	PTFE
7. Impeller	PP



Cross-section of pump:

When fluid enters the wave channel, a surge hole allows it to escape into the fluid area surrounding the pumping unit. In the wave channel is no overpressure and the fluid level in both (wave channel and drum) is always the same. For this reason the pump doesn't need a seal between drive shaft and housing.

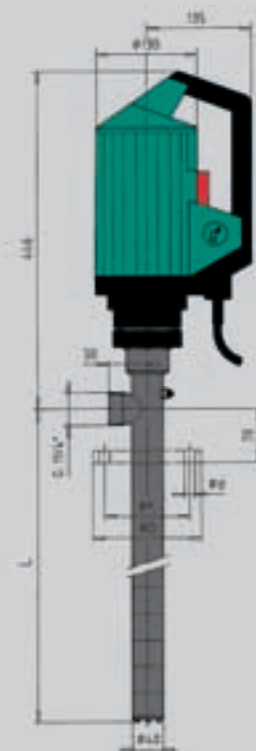

**Mechanical sealed (MS) pumps
in separate catalogue.**



ACCESSORIES

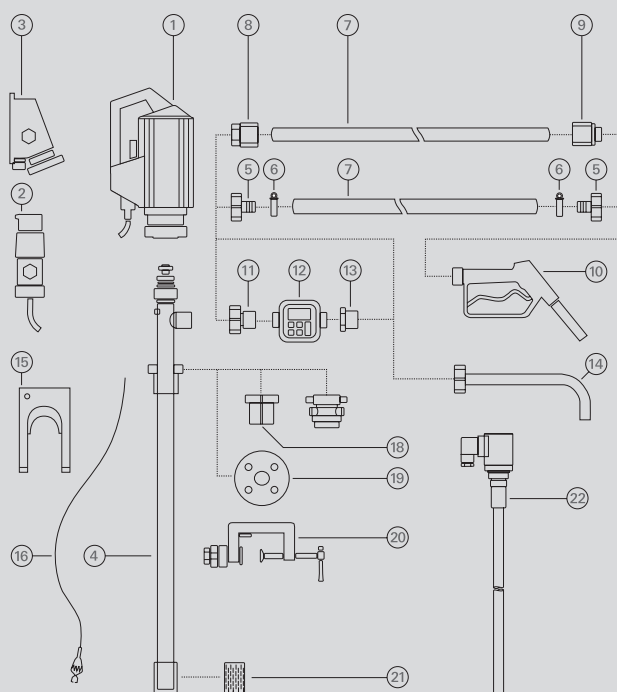

- 1 Drive motor
- 2 Explosion-proof plug
- 3 Explosion-proof socket
- 4 Pump tube
- 5 Hose connector
- 6 Hose clamps
- 7 Hose
- 8 Hose fittings
- 9 Hose fittings
- 10 Nozzle
- 11 Flow meter connection
- 12 Flow meter
- 13 Reducing piece
- 14 Discharge spout
- 15 Wall bracket
- 16 Equipotential bounding cable
- 17 Emission proof drum adapter
- 18 Drum adapter
- 19 Installation flange
- 20 Clamping device
- 21 Foot strainer
- 22 Level switch

Distributor:



grün-pumpen gmbh

Aleksandar Henc
mašinski inženjer
Menadžer prodaje - SEKTOR PUMPI

Tel: +381 11 63 098 17
Mob: +381 64 859 39 79
Fax: +381 11 63 098 20
Email: aleksandar.henc@hennlich.rs

Handelsregister:

Reg. Gericht Mannheim
HRB 570326

Sitz der Gesellschaft:
Wertheim

Geschäftsführer:

Ralph Dostmann,
Dr. Thomas Sigel
USt.IdNr. DE 160765854

